

# OPC UA Users and Experts – Conveying Knowledge and Experience

First Edition | November 2020

The OPC Foundation publishes a series of interviews with experts, market leaders and think tanks in communication, automation and industrial IT to highlight the benefits and the potential of the OPC UA technology for end users, system integrators, operators in the world of industrial IoT.

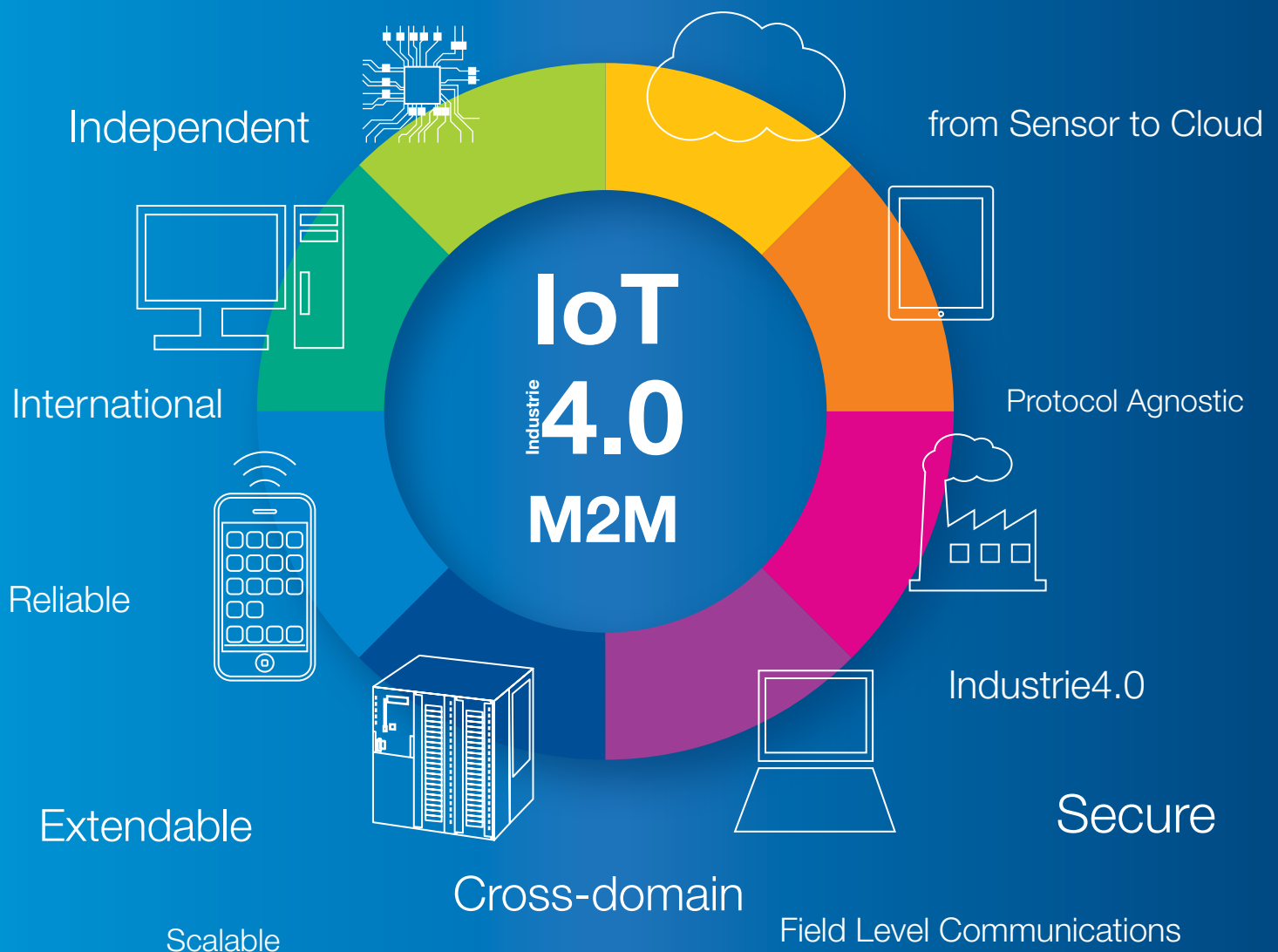

# Contents

- 4 DIRECTOR'S WELCOME**  
The Technological Awakening
- 5 CHAPTER 1: OPC UA FOR OPEN PROCESS AUTOMATION**  
OPC UA was selected by the Open Process Automation Forum of The Open Group in 2018 as the industry standard for its Connectivity Framework. Don Bartusiak, President of CSI Automation, provides an overview of Open Process Automation and describes the rationale behind selecting OPC UA.
- 7 CHAPTER 2: WHAT IS OPC?**  
An Interview with Stefan Hoppe, President and Executive Director of the OPC Foundation.
- 11 CHAPTER 3: THE TECHNOLOGY BEHIND OPC UA**  
Learn how the science of the open platform communication standard, OPC UA, is applied across the industrial automation sector from an interview with Uwe Steinkrauss, CEO of Unified Automation.
- 14 CHAPTER 4: THE FIELD LEVEL COMMUNICATIONS INITIATIVE OF THE OPC FOUNDATION**  
Peter Lutz, the Director of Field Level Communication at the OPC Foundation explains FLC's goals, the various parties involved, including committees and working groups. He will share relevant use cases and how FLC will adapt to upcoming trends and technologies.
- 18 CHAPTER 5: VDMA COMPANION SPECIFICATIONS**  
Learn from an interview with Andreas Faath about OPC UA Companion Specifications coordinated by the Mechanical Engineering Industry Association (VDMA). Andreas will describe the role of VDMA and companies involved in the unique process of developing companion specifications, the contents of these standards, and how you can become involved.
- 22 CHAPTER 6: OPEN SERIALIZATION COMMUNICATION STANDARD**  
Marcel de Grutter of Abbott Healthcare in his role as Executive Director of the OPEN-SCS Working Group describes OPEN-SCS, the OPEN Serialization Communication Standard. He will explain the purpose of OPEN-SCS, what serialization means, what developments have been driven forward in this area by COVID-19, and the role OPC-UA plays as the base communication architecture. .
- 27 CHAPTER 7: MICROSOFT OPC UA CLOUD SOLUTIONS**  
Learn from an interview with Erich Barnstedt from Microsoft about the role OPC UA plays in industrial IoT. Among other things, he will tell us what open source contributions Microsoft have made to the OPC Foundation, and what the Azure Industrial IoT platform offers.
- 32 CHAPTER 8: SMART FACTORY WEB**  
Thomas Usländer from Fraunhofer IOSB research institute describes the Smart Factory Web and the role it plays in OPC UA. Among other things, Thomas will discuss major trends in smart manufacturing, discuss Smart Factory Web, how it relates to IoT and other initiatives, and why they chose OPC UA as their underlying architecture.

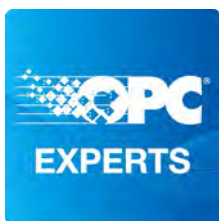

OPC Foundation Podcasts are available on different distribution channels like ...



Spotify



iTunes



Google



your computer

# OPC FLC INITIATIVE WEBINAR DEC 01, 2020

**DIGITAL EVENT**

08h – 11h CET Presentations and Q&A (Europe & Asia)

08am – 11am PST Presentations and Q&A (America & Europe)

## AGENDA

- 1. OPC in the World**  
World update, new collaborations, specification update  
Stefan Hoppe, President OPC Foundation
- 2. OPC FLC Initiative – Introduction**  
Peter Lutz, Director FLC OPC Foundation
- 3. Architecture – Clark Case, Rockwell, WG Architecture Chair**
  - How does the overall system architecture look like?
  - What are technologies that FLC is being based on?  
(OPC UA + IEC/IEEE Standards + Cooperations for Safety/Motion)
  - What are the different components of the system architecture? Safety, Security, Transport, ...
- 4. Information Modelling – Paul Hunkar, Yokogawa, WG Info Modelling Chair**
  - How are automation components (controllers and field devices) being modelled?
  - How does the asset model look like – with example(s)?
  - How does the functional model look like – with example(s)?
- 5. Connecting Devices – Georg Biehler, Siemens, WG Connecting Devices Chair**
  - What are logical connections and which types exist?  
(Unidirectional, Unidirectional with heartbeat, Bidirectional)
  - How do logical connections map to OPC UA communication models?
  - How are logical connections between automation components (controllers) established?
  - What is the role of the connection manager and the connection state machine?
- 6. Offline Engineering – Emanuel Kolb, ABB, WG Offline Engineering Chair**
  - How are devices configured offline?
  - How are product descriptors and configuration descriptors structured?
  - How does a typical configuration workflow for TSN and non-TSN-based Systems look like?
- 7. Functional Safety – Max Walter, Siemens, WG Safety Chair**
  - What are the use cases for functional safety?
  - How does the overall Functional Safety concept look like?
  - How is OPC UA Safety embedded in the overall system architecture?

The presenting WG Chairs will use content out of the Release Candidate RC1, preview and pre-information on later Specification Release. For High-Level we link to the Technical Paper – “Theory of Operations”

For more information please navigate to

<https://opcfoundation.org/FLC>

<https://opcfoundation.org/APL>





**Michael Clark**

Director, OPC Foundation North America

[mike.clark@opcfoundation.org](mailto:mike.clark@opcfoundation.org)

## Director's Welcome The Technological Awakening

For over 32 years, I have been actively engaged in the industrial process control sector, in industries like water and waste water, oil and gas, food and beverage, chemicals, mining, and myriad other disciplines. During a particular season of my career, in the mid- '90s, a new technology emerged called OPC. It was developed to help industry break away from proprietary communication technologies, thus permitting HMIs and SCADA systems to harvest data from controllers in plant areas. There were limitations in some of the supporting technologies of that era, e.g., Microsoft DCOM. While OPC and its client/server communication infrastructure helped solve some data exchange problems of the day, the need for customized drivers was apparent.

The OPC technology of the '90s, now known as OPC Classic, was something with which I had limited exposure because I was preoccupied with the pre-canned, proprietary systems offered by the big automation suppliers. Perhaps this pattern sounds familiar to a few of you; however, during this period of automation renaissance, some pretty fantastic developments transpired.

OPC UA (Unified Architecture) was developed between 2003 and 2006, and has been continuously enhanced ever since, providing outstanding results. Not the least of which was specifying information exchange between OT and IT systems, being OS agnostic, and being protocol independent, all while communicating from the device to the cloud. Furthermore, OPC Foundation baked-in security for access-control, authentication, and encryption.

So, how was I finally awakened to this reality? Well, since 2011, I have been involved in some of the early investigations that ExxonMobil had done into what is now known as the Open Process Automation Standard, or O-PAS™. Since its official kickoff in 2017, the standard has referred to itself as “a standard of standards.” Would it come as a surprise to anyone, which standard O-PAS chose for information modeling and data exchange?

Because OPC UA is a vendor-independent, secure, and scalable standard, and because it supports discovery, interoperability and portability, it became the obvious choice for inclusion into O-PAS. Since I am one of the contributing authors to the OPA Standard, I needed to take a crash-course in OPC UA technologies; and did that ever open my eyes!

In April of 2020, I began my tenure as the Director of OPC Foundation North America. Yes, my learning curve went completely vertical, but I'm delighted to be involved. The process automation industry is in for quantum enlightenment as we learn together what OPC technology will do for our respective applications. I'm here to help.

We have compiled this eBook for your benefit. Automation.com is distributing this publication to a broad process automation audience. As you study each article, you will have questions; I did. Please ask them. Please feel free to contact any of our contributors or myself at: [mike.clark@opcfoundation.org](mailto:mike.clark@opcfoundation.org). Each article within this eBook has been selected for inclusion because of its relevance to a broad spectrum of themes meant to cover a wide array of topics. We express sincere thanks for the contribution of the experts who were interviewed for this publication.

You'll be happy to learn that new articles and podcasts are being created all the time. A few notable articles, for which you may want to keep your eyes open, include: Google Cloud integration; OPC UA over MQTT, UA for Cloud Libraries & CESMII; MDIS Companion Specification; and many more.

I hope you enjoy the read.

Mike



R. Donald Bartusiak, Ph.D., President, Collaborative Systems Integration, LLC don.bartusiak@csi-automation.com

# OPC UA for Open Process Automation

### IN THIS SECTION:

OPC UA was selected by the Open Process Automation Forum of The Open Group in 2018 as the industry standard for its Connectivity Framework. Don Bartusiak, President of CSI Automation, provides an overview of Open Process Automation and describes the rationale behind selecting OPC UA.

Open Process Automation (OPA) is an industry initiative to define a “standard of standards” (O-PAS™)<sup>1</sup> for an open, secure, interoperable process automation architecture. The standards enable development of fit-for-purpose industrial control systems consisting of cohesive functional products acquired from independent suppliers and integrated easily via a modular architecture characterized by open standard interfaces between products. The market need that this initiative addresses is that currently available industrial control systems are expensive to upgrade and maintain, and are challenged when trying to insert new technology, especially from third parties.

### How is OPC UA used in OPA?

The OPA reference architecture is depicted in Figure 1<sup>2</sup>. OPC UA is used for the O-PAS Connectivity Framework that defines the data transport means for communications among the nodes in an O-PAS based system<sup>3</sup>. OPC UA is used to define the object-oriented information models for the interfaces among the software applications in the system<sup>4</sup>. Also, OPC UA is used as the basis for the alarm specification of O-PAS<sup>5</sup>.

### Why was OPC UA selected for O-PAS?

The OPA Forum, during its 2017 formative year, defined and documented a set of foundational principles and quality attributes to guide development<sup>6</sup> of the O-PAS standard. Among the seven principles that govern The Open Group’s process for standards development, the two that are most relevant for this article are the following: #4 Public availability of

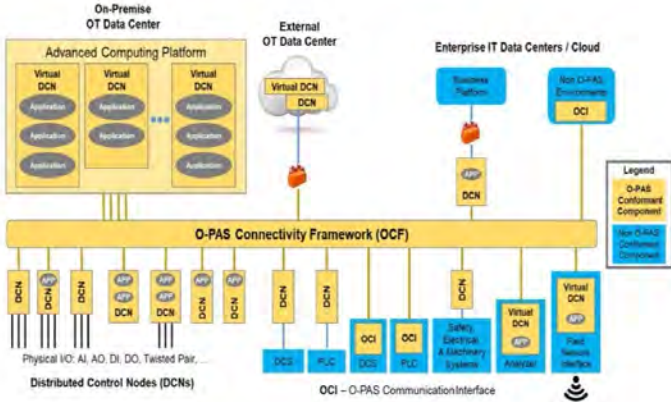

Figure 1. Open Process Automation reference architecture (© The Open Group)

published specifications, and #5 No legal impediment to implementation or adoption. Among the “top ten” quality attributes that govern development of the O-PAS standard<sup>7</sup>, the following are most relevant for this article:

- Interoperability
- Securability
- Portability

- Availability
- Discoverability

Several industry standards were considered for the O-PAS Connectivity Framework. After several months of deliberation, the OPA Forum voted to select OPC UA as the referenced standard. Writing with the benefit of hindsight and from my perspective as OPA Forum Co-chair, I cite the following three reasons for why OPC UA was selected for the O-PAS Connectivity Framework:

1. OPC UA is strongly supported by the industrial control system supplier company members of the Forum.
2. OPC UA satisfies the business principles that govern The Open Group's standards development process.
3. OPC UA satisfies key quality attributes – notably interoperability, securability, and discoverability – that govern development of O-PAS.

### What's next for OPC UA with O-PAS?

As operating companies, system integrators, and hardware/software suppliers collaborate to build their first instances of O-PAS based systems, it is imperative that OPC UA work in practice. Arguably, the quick consensus on selection of OPC UA for O-PAS was based on it as a theory. First-use experiences with OPC UA – actual implementations, not the OPC UA standard per se – by Saudi Aramco<sup>8</sup> and ExxonMobil<sup>9</sup> have documented challenges with respect to data throughput, variations in implementations by different OPC UA software development kit suppliers, and security certificate set-up. I am confident that these early-use problems will be eliminated by means such as the following:

- Conformance validation and formal certification of OPC UA products by the OPC Foundation and The Open Group<sup>10</sup>
- Industrial quality software toolchains
- A developed body of best practices among suppliers and users

### Conclusions

The selection of OPC UA was a key success factor in the customer-supplier consensus-based development of the Open Process Automation Standard. For OPC UA now, it's showtime.

### References:

- <sup>1</sup> Trademark of The Open Group
- <sup>2</sup> The Open Group. (2020). "O-PAS Part 1". <https://publications.opengroup.org/p201>
- <sup>3</sup> The Open Group. (2020). "O-PAS Part 4". <https://publications.opengroup.org/p201>
- <sup>4</sup> The Open Group. (2020). "O-PAS Part 6.2". <https://publications.opengroup.org/p201>
- <sup>5</sup> The Open Group. (in-press). "O-PAS Part 6.3".
- <sup>6</sup> The Open Group. (2020). "The Open Group Standard Process". <https://>

[www.opengroup.org/standardsprocess/standards-dev.html](https://www.opengroup.org/standardsprocess/standards-dev.html)

<sup>7</sup> The Open Group. (2018). "Open Process Automation Business Guide". <https://publications.opengroup.org/g182>

<sup>8</sup> Sait SM, Al-Hashim GA. (2016). "Novel design of a collaborative automation platform using real-time data distribution service middleware for an optimum process control environment". J. of Circuits, Systems, and Computers. 25(6):1-32.

<sup>9</sup> Bartusiak RD, Bitar S, DeBari DL, et al. (2020). "Open Process Automation: A standards-based, open, secure, interoperable process automation architecture". Proc. IFAC 2020 World Congress.

<sup>10</sup> The Open Group. (2020). "Open Process Automation Certification Policy". <https://publications.opengroup.org/x201>

---

### ABOUT THE AUTHOR:

Don Bartusiak is President of Collaborative Systems Integration, and Co-chair of The Open Process Automation Forum. In Oct 2020, he retired as Chief Engineer, Process Control for ExxonMobil Research and Engineering with 33 years of experience. From 1977 to 1984, he was a Research Engineer for Bethlehem Steel. At ExxonMobil, he implemented real-time artificial intelligence, linear and nonlinear model predictive control, and real-time optimization applications. From the mid-1990s, he held supervisory or senior technical positions responsible for instrumentation, process analyzers, control systems, and control applications. From 2000 to 2002, he was Adjunct Professor at Rice University.

Don received a B.S. from the University of Pennsylvania and M.S. and Ph.D degrees from Lehigh University. He has published ten journal articles and is co-inventor on five patents.

### Professional activities and Awards

- Former Director of AIChE CAST Division
- International Federation of Automatic Control (IFAC) Committee for Chemical Process Control
- Executive Board Member and Managing Director for ISA
- AIChE CAST Division Computing Practice Award (2011)
- ISA Excellence in Leadership Award (2018)
- IFAC Fellow (2020)



**Stefan Hoppe**

President and Executive Director OPC Foundation  
[stefan.hoppe@opcfoundation.org](mailto:stefan.hoppe@opcfoundation.org)

## What is OPC?

**AN INTERVIEW WITH STEFAN HOPPE,  
PRESIDENT AND EXECUTIVE DIRECTOR OF THE OPC FOUNDATION.**

---

### What is OPC, who is it for, and why should one care?

**HOPPE:** Well, today the acronym OPC stands for Open Platform Communications. OPC is an interoperability standard which allows a secure and reliable data exchange in the area of industrial automation and other industries. OPC is a completely independent platform that allows data to move seamlessly between multiple devices from different vendors. It scales from sensor to cloud. Users care about this technology for many reasons, including a key role that OPC plays in Industrie4.0 and IIoT – making data available across every automation sector.

### What is the OPC Foundation and its role?

**HOPPE:** The OPC Foundation develops and maintains the entire set of OPC specifications, but we also provide mechanisms to ensure the quality of these standards through associations with compliance labs and various test tools. Since the specification provides the mechanisms describing “how” to move data, we also collaborate with many other associations, defining “what” to exchange.

Here at the OPC Foundation, we feel a little bit like the United Nations of automation, especially since our goal is to remain completely independent – One big vendor cannot define the direction of the Foundation nor what it is to do – It’s democratic. Each year, half of the board members are democratically elected, so no one can buy influence with money. We are completely independent in taking care of this standard.

### How can you, as an organization, accomplish such a huge goal?

**HOPPE:** Well, first of all, you need to define a goal upon which everybody in the world can easily agree. Then, of course, you need a critical mass of

companies to support this. The easy vision of the OPC Foundation is to provide a standard where users and vendors come together to define a mechanism to transfer data from multiple vendors and multi platforms in a secure and reliable way. Since this applies to the area of industrial automation, it has to scale in different areas. That’s an easy-to-understand goal because everybody comprehends the benefits.

Secondly, it’s important to keep the organization independent so that nobody believes it is driven by a specific company. Acting independently is the key for us to refer to ourselves as the United Nations of automation. We want to be the neutral ground upon which everyone can easily meet.

### Can you give us a little insight into the history of the OPC standard, why and how it came to market, how old or how young it is, and its major milestones?

**HOPPE:** I don’t want to spend a lot of time on its history, but I can tell you a secret – OPC, in its early days, was called OLE for Process Control. In 1990, SCADA companies had to write a lot of proprietary drivers to connect to PLC controllers. The idea was born to take the Microsoft COM/DCOM printer driver concept, to have standardized access to the upper (north-side) port, and establish a proprietary last-mile to all the different PLC controllers. That was the birth of what we now know as OPC Classic. It provided live data, alarms, and historical data. It was massively successful. We had broad adoption inside the industry, but, of course, we recognized later that we needed to be platform independent; we needed to integrate security; we needed a service-oriented architecture mechanism inside. That’s why, from 2003 through 2006, we started separating services from data. This was the birth of OPC UA. UA stands

for Unified Architecture. We unified everything together into one architecture and then we validated everything; we made prototypes; and then, at last, in 2008, OPC UA was released.

Since then, we've had products on the market with no compatibility break. Modern cloud applications connect to OPC data, even to devices from 2007. Today, OPC UA is a complete technology, independent from operating systems, independent from vendors, and it has security built in, by design. That's really important to understand.

**Who are your members and what countries are they from?**

**HOPPE:** All kinds of companies, in all kind of areas throughout the world. I believe that OPC is the largest ecosystem for industrial interoperability, worldwide. Our members are very small companies, the big giants of the market, providers of technology, and, of course, end-users. The status today is that OPC Foundation has more than 750 members in all regions in the world. Analysts say that we have more than fifty million applications worldwide – It's a huge ecosystem. Statistics indicate that 50% of our members are headquartered in Europe with around 25% in the US and 25% in Asia, but I see that Europe and Asia are growing very quickly.

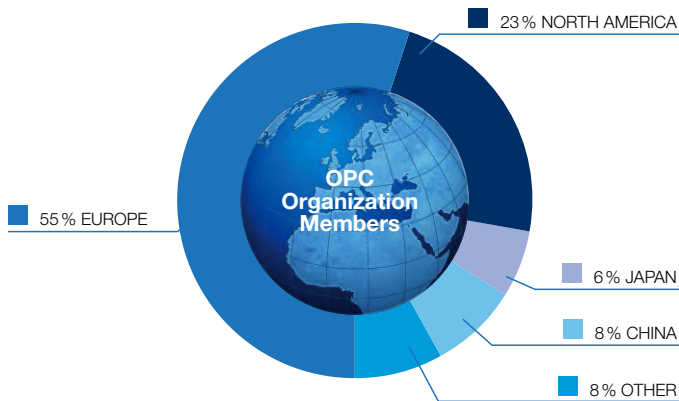

**What would you say is the is a major driver for this difference in acceptance across the global markets?**

**HOPPE:** Well, in Europe, there is the initiative called Industrie4.0, which is named differently in a couple of countries. It's all about how to make workflows more efficient; how to get data.

The scope of Industrie4.0 is huge; starting with how to design a product, consideration for its entire life cycle, including the end of a product. Whereas, OPC UA addresses mainly but not exclusively how to connect during the production phases of the live data. The idea is easy to understand; you need something like a USB connector for machines, which allows you to reduce engineering costs, and provides standardize data. Think of the benefit of having OPC UA in a device (or a machine) and then being able to connect this machine within only 10 minutes to SAP MES, or Microsoft Azure, to name just two of them. It is easy to understand. That's exactly why end-users like Volkswagen, Samsung, Foxconn, Miele, and others have joined the Foundation; because they understand these big benefits. That's a key value.

**Tell us a little bit about the technology behind the OPC standard.**

**HOPPE:** That's not easy to explain – and we will definitely have separate podcasts on that topic – but let me address it briefly in three blocks. Before I do, however, we have to understand that OPC UA is not another protocol. We have so many, we don't need another one. In today's world, I believe that protocols are not really a high-value item. What is valuable is the secure exchange of information and to know the meaning of that information.

So, first of all, with OPC UA, you are describing and modeling data interfaces that your machine or device should expose via live data, historical data, alarms, and so on.

Then, secondly, deeper within the OPC UA framework, we see different communication mechanisms built in already by design. Client/server is one, publisher/subscriber is another. These are still independent from the real protocol beneath.

The third block is the real protocol binding layer. Here we are using OPC over TCP, HTTPS, UDP, MQTT or whatever other protocols may come in the future. Here you really see the benefits, because you are defining data and information. Keep in mind, these models will persist for many years to come, even when OPC is extending the protocol mechanisms to support more endpoints for new and existing protocols, for even more use cases.

Although designing data models is of key importance, security must be built in by design; and not just for the transport layer. Security also applies to authentication, those who are allowed to access particular kinds of data; how I manage a big factory; how I perform discovery and certificate management automatically, and so on.



Graphic: OPC UA is not a protocol – instead it's a framework to exchange standardized data with end-to-end integrated security scaling from sensor to cloud

So, you see that OPC UA is much more than a protocol. That's why we are not comparing OPC UA to protocols by asking, "should I use OPC UA or MQTT?" No! More correctly, we are using MQTT inside the OPC UA architecture! This allows us to move standardized data up into cloud scenarios.

**As a standard, how do you make sure providers of the OPC technology stick to the rules? Do you certify their products?**

**HOPPE:** In the beginning, the OPC Foundation started as a community of vendors creating their own tools, for example, the CTT tool [Compliance Test Tool], which OPC corporate members can get at no cost. But you don't even have to be a member paying member fees; you can just buy that tool.

I believe that, today, the CTT performs 2000 test cases which you can run against your product to prepare yourself so you can deliver a higher quality product. Alternatively, we have labs in different regions throughout the world to test your product. Manufacturers can even participate while sitting next to the test lab engineer, if they wish. We perform





Graphic: The OPC Foundation closely cooperates with organizations and associations from various branches. Specific information models of other standardization organizations are mapped onto OPC UA and thus become portable. The organizations define „what“ shall be communicated. OPC UA delivers how through its secure and effective transport and offers access privileges and generic interoperability.

multiple tests on many different products; things like stability tests over 36 hours, looking for memory consumption, and so much more.

**What about collaboration with other international organizations; why would other organizations be interested in working with the OPC Foundation?**

**HOPPE:** Well, the other associations have the domain specific knowledge – they know about a robot, an injection molding machine, or a coffee machine – this is not the specific knowledge of the OPC Foundation. We are able to move data in a secure way; and scale it from sensor to cloud. So, collaborating with these associations is a perfect win-win situation. I’ll say it in easier words: The OPC foundation provides the technology for “how” to exchange data and information in a secure way, and our partners define the “what” – they define the vocabulary of data and interfaces, ensuring, for example, that all robots have the same parameters, the same interfaces, and provide the same meaning.

**You mentioned one or two, but what other companion specifications exist today?**

**HOPPE:** Today, we have about 52 active collaborations – all of them publicly documented – they are on the Foundation’s website where you can download a .pdf document wherein you can see who is responsible for running each group. If you wish, you can simply contact the chairperson to become an active member or, perhaps, just a listening member, reviewing documents so you can inform yourself as to what’s going on. Of course, I can’t list them all here but just to name a few: In the United States there is an initiative sponsored by the MDIS network [MCS-DCS Interface Standardization] focused on standardizing communications between subsea and topside equipment among offshore oil and gas systems.

In Europe the VDMA [The Mechanical Engineering Industry Association] is supporting more than 22 companion specifications. They are Europe’s largest association in the disciplines of the mechanical engineering industry; this covers robotics, injection molding machines, and more. We are also involved in areas like the pharmaceutical industry, participating in the OPEN-SCS [Serialization Communication Standard] initiatives; the tobacco industry; the energy industry. But then, there are also generic topics, which are independent from a market; topics like Asset Management. Additionally, we are supporting commercial kitchen equipment initiatives – there, too, is an industry where standardized data models are needed.

**Can members or others initiate collaborations?**

**HOPPE:** Starting a new initiative depends a little bit, since everybody in the world can write an OPC UA companion specification. You start by going to the OPC website, downloading the publicly available documents, and then you start filling them in. For example, let’s say I want to model a coffee machine. Well, we have that standard already, but you can do it again, on your own, if you want. Then it’s your own companion spec; your company driven companion spec. The OPC Foundation tries, first, to do collaborations with other associations; then we need to draft a memorandum; then we do a call for participation; then we provide all the compliance rules, etc... The idea, really, is to work with associations throughout the world, to have a broader acceptance and a broader adoption across global industries.

**OPC Foundation introduced the Field Level Communications group. Can you tell us more about this major initiative?**

**HOPPE:** Yes. It was very important to integrate this initiative under the roof of the OPC Foundation because it’s extending the vision of OPC UA for the independent, secure movement of information from sensor to

cloud. This addresses requirements of both factory automation and process automation. We explicitly include deterministic communications, which we are establishing in the future with TSN [Time Sensitive Networking], plus future integration of 5G networks, but also functional safety and motion.

Each of these three major functions – deterministic communication, functional safety, and motion – are options which users will be given the choice to enable. An example would include a case where an end-user may choose to enable deterministic communication between two controllers from different ecosystems. I believe the safety standard will be delivered earlier Industrie4.0. For the TSN and also 5G this will take more time because it's really highly complex to handle all these topics to configure a network of TSN enabled devices in the same way. This will not be something available within a year or something like that

### **Is there anything else that is, or has been in the news that you would like to share with our readers?**

**HOPPE:** I was at the EMO Trade Show in Hannover ...it was so amazing that, within just one year, 70 companies from 10 countries around the world – not Europe only, it was the United States, China, Japan . Korea, Taiwan, they came together from everywhere; they agreed on vocabulary; they agreed on what data to exchanged; they called this initiative UMATI [Universal Machine Tool Interface].

At that trade show, 110 machines and 28 software packages from these 70 companies out of 10 countries, inter-connected and were showing their data in an exactly identical, semantic way. I saw big dashboards and could navigate into one hundred and ten machines. That was a huge success and I truly believe we will hear more from them in the future.

Well, looking now to the future, what I'd like your readers to remember is that if we are writing companion specifications, with a lot of partners, for a lot of machines, in different markets throughout the world; if you envision these companion specification, like a book –each book describing a machine, the types of interfaces it has, the meaning of its data, the behavior of the machine, and then, as a result, you have a huge collection of books – the OPC Foundation then becomes the world library of descriptions of industrial devices and industrial things.

That's exactly what's happening right now, although there's a lot of overlap. A robot may need an MES interface; a robot may need overall efficiency data; in the future, a robot might have a power management interface ...and a whole lot more. These features may also turn out to be things that other machines might need; not only in factory automation, but also in the area of process automation.

Harmonizing all this data and all these interfaces is something that the OPC Foundation manages. As such, we started a new working group that has created an online platform – a library. It includes all of these companion specification groups, their information, and what they believe is critically important for others. You don't need to go into a store to buy a book since everything is available electronically these days.

Simply go to the OPC website [opcfoundation.org] and navigate throughout this online library to learn if a group has already worked on something in which you're interested. Perhaps you can re-use parts of that existing product. Again, the OPC Foundation helps to harmonize these work-products to make results better. This is, for me, critically important, because I truly believe that, in the future, we will have automatic code gen-

erators referencing sources within this online library. For example, I envision the time when the Foundation provides access to artificial intelligence systems so they know, exactly, the meaning of a particular, standardized data set.

### **Why did you decide to start running a podcast?**

**HOPPE:** In earlier years, when we were all much younger, there were only books for us to read. Today the world is much more colored. We are hosting videos on the OPC YouTube Channel but our viewers are also listening to interesting topics. I think this has a high value and that's why we decided to go on this channel – not only visual – but audio now.

We wish to provide a good overview of OPC technology and involve multiple, international experts to cover different topics. We can do a deep dive into technology; how it works; the protocol binding; talk about security; etc.

We want to report on all the collaborative work going on, in a deeper way. We will share information on how you could start, if you wanted to get more involved. We will invite end-users to talk about their experiences. So, there are a lot of ideas which we have in mind. That's why I'm looking forward to creating many podcasts.

### **Perhaps some readers maybe want to become a member of the OPC Foundation. What is the best way for them to do that?**

**HOPPE:** Well, the landing page of the OPC Foundation is definitely a good starting point. It's [opcfoundation.org](http://opcfoundation.org). There, you'll find all kinds of information; you can download brochures about OPC UA technology; you can find a link to all the YouTube videos; you'll see an overview of all the international events. Perhaps there is one in your region, or even online. There's a lot of information.

You can find a section outlining member benefits, being part and getting early insights. Overall, I believe this is the biggest benefit to being a member, because once a specification is released everything is publicly available anyway.

We have public open source-code and all the released specifications are publicly available. Non members can buy certification tools, but if you want to have insights on what's going on, and what's influencing your world within the next two or three years, then you should become a member, then you have the early insights.

---

### **ABOUT THE INTERVIEW PARTNER:**

Since 2018, Stefan Hoppe has served as the OPC Foundation President, coordinating the OPC expansion into the Internet of Things & Industrie4.0.

Prior to serving as President, beginning in 2014, Stefan was the Global Vice President and, since 2010, the President of the OPC Europe organization. In these positions, he became the catalyst for initiating liaison relationships with other industrial consortiums, which has resulted in OPC working groups developing companion specifications for the organizations respective information models. Mr. Hoppe studied electrical engineering at the Technical University of Dortmund, Germany. Since 1995, he has worked for BECKHOFF Automation, starting as a software developer later as a lead Product Manager focusing on PC based Automation, connectivity, and embedded software products.

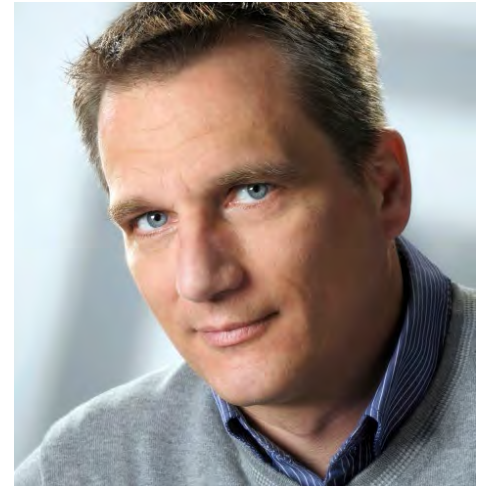

**Uwe Steinkrauss**, CEO, Unified Automation  
[uwe.steinkrauss@ascolab.com](mailto:uwe.steinkrauss@ascolab.com)

## The Technology Behind OPC UA

### IN THIS SECTION:

Learn how the science of the open platform communication standard, OPC UA, is applied across the industrial automation sector from an interview with Uwe Steinkrauss, CEO of Unified Automation.

**MICHAEL CLARK: Uwe, please introduce yourself to our readers: Tell us a bit about yourself, your company, Unified Automation and your involvement to date with OPC and the OPC Foundation.**

**UWE STEINKRAUSS:** I am the CEO of Unified Automation and we are based in Nuremberg, Germany. We do Software Development Kits and Toolkits in all programming languages. Our customers use these Libraries to integrate OPC UA into their devices. We have implemented OPC UA tools and solutions since its inception in 2006, when OPC UA first started. We are involved in the Technical Working Groups, Prototyping, and Test and Certification activities of the OPC Foundation. We help drive the OPC UA standard forward by continuously contributing and supporting marketing events, roadshows, fairs, and tradeshowes of the OPC Foundation.

**CLARK: Technologically speaking, how is OPC UA different, relative to other standards?**

**STEINKRAUSS:** OPC UA is the first industrial-grade communication standard that combines data modeling with a secure transport. One is nothing without the other, but this combination is the key to success.

**CLARK: What is so special about secure transport; don't other secure protocols exist as well?**

**STEINKRAUSS:** WYes, that is absolutely correct but the continuity from the smallest data source up to the consumer of the information, across all levels, has never before existed; especially not within the industrial automation sector. OPC UA brings end-to-end security down to the shop



floor. And we are not talking about encryption only; OPC UA adds access-permissions down to a single process value.

**CLARK: Tell us about the concept of modelling, what it is, and for what purpose it is intended.**

**STEINKRAUSS:** We need modeling to describe “things”. To be more precise here, we need to describe the meaning of the data and we need to deliver the so-called “metadata” out-of-the-box. This is the precondition for Plug & Play or Plug & Produce. We need self-describing things and self-describing data. OPC UA offers an object-oriented description model that enables you to describe any kind of data. By describing it's meaning, OPC UA turns raw data into useful information. The metadata is conveniently included and can be read just like the data itself.

**CLARK: So, does every company produce their own model of their machines and equipment? What if users of different machine brands want to interact with these machines; do they**

**need to understand all the different models?**

**STEINKRAUSS:** Each device or machine vendor could create their own model, but the real benefit of modeling data is achieved when creating standardized models. The so-called companion specifications describe such models for an entire group of machines/devices or a branch/use-case. Besides generic access, which will always work, applications can be “specialized” within the data model. Therefore, they can do special things with this data, because they “understand” the data. This is an important requirement for flexible and “smart” networking.

**CLARK: The OPC UA standard provides two communication mechanisms: Client-Server and Publish-Subscribe, also known as Pub-Sub. Why not concentrate on just one?**

**STEINKRAUSS:** OPC UA has two communications mechanisms because both are needed to meet all the requirements of industrial automation applications. Each one has advantages for certain use cases. Such use cases expand even beyond industrial automation.

**CLARK: OK, so when does one use Client-Server; and why? What is the advantage of using Client-Server?**

**STEINKRAUSS:** Client-Server communications use a Request-Response paradigm. The Requestor (the Client) gets only what it asked for. Client-Server uses Peer-to-Peer connections based on TCP/IP. OPC UA defines an abstract service API which implements a Service Oriented Architecture (SOA). The resulting advantage is reduced bandwidth, since only that which was requested is transferred; and only when it has changed. Secondly, there is robust transmission. Client-Server communications run within the context of a session and have configurable timeouts for each and every service call. Additionally, there is a keep-alive mechanism which monitors both the Client and the Server, confirming each is active on the network. The Client-Server messages have sequence numbers, response confirmation, plus acknowledgement within the next request. Furthermore, Client-Server subscriptions have data queues and retransmission on Layer 7. Simply said: nothing gets lost, even if the physical connection was interrupted. Once the session is re-established, all the data and events that occurred during the outage are presented.

**CLARK: The same question applies then for Pub-Sub; when do we use it, and to what advantage?**

**STEINKRAUSS:** The Publish-Subscribe model is a different way to access data. Simply said: if only the last value is the exciting one, you should consider Pub-Sub. Pub-Sub uses UDP-Multicast to address communication in one-to-many scenarios. The Publisher repeatedly sends out the DataSet across the

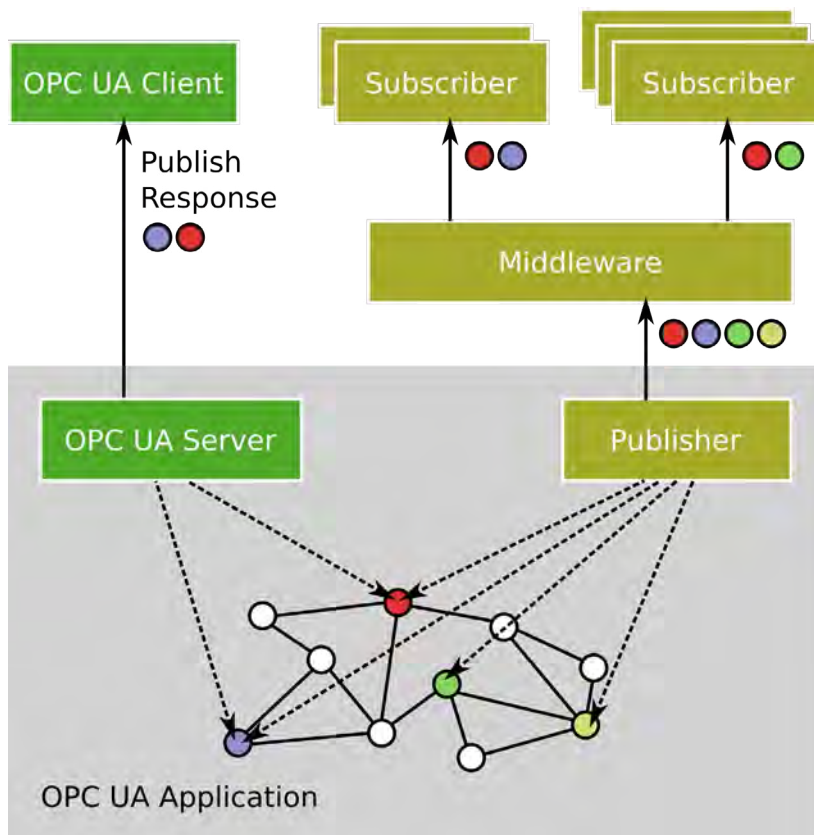

Client/Server and Publish/Subscribe models.

network, upon which many subscribers are listening. The advantage to this is that publishers can reach many receivers with minimal CPU and memory resources (a low-cost device) on the sender's side. Secondly, with Pub-Sub, networks can realize very fast transmission speeds within the local subnet. But, be aware, there will be no backup, queue, re-transmission, or flow control, whatsoever. Therefore, a stable, Layer 2 network infrastructure is needed; hence, quality of service (QoS) plays an important role with Pub-Sub.

**CLARK: Tell us about TSN and how it plays into deciding which communication mechanism to choose.**

**STEINKRAUSS:** TSN [Time Sensitive Networking] provides the aforementioned stable, Layer 2 network infrastructure, including a high level QoS. OPC UA and Pub-Sub can utilize many different transports but let's focus, for this example, on using TSN. In contrast to the best-effort principle, as seen in a regular package-oriented network, deterministic data transmission is possible over TSN. Now, OPC UA can serve use-cases where “timeliness” is important, such as motion control and functional safety applications.

**CLARK: Now that we have received a base understanding of both communication mechanisms: does one have to choose either Client-Server or Pub-Sub?**

**STEINKRAUSS:** No, ideally you don't have to choose. Both variants are available in parallel in most OPC UA capable devices. When considering a TSN or 5G infrastructure, one can use OPC UA at the lowest field level inside a machine. But even without TSN, anyone can use Pub-Sub in a machine or production line.

On a controller, at the HMI/SCADA level, or even in the MES/ERP at the factory level, users would probably prefer Client-Server communications, in keeping with the no-loss-of-data principal. Similar preferences likely apply when using OPC UA for configuration and engineering purposes. Within IT or cloud applications, users could employ either or both. For a constant stream of pure telemetry data, Pub-Sub may be sufficient; however, for command and control, users would opt for service-oriented Client-Server.

The majority of OPC UA enabled devices come with both options. The use-case dictates which is best for the job.

**CLARK: In the IT world, and especially in cloud applications, communication protocols like AMQP or MQTT exist. Do I continue using them instead of OPC UA or how does OPC UA deal with them?**

**STEINKRAUSS:** OPC UA figured it out correctly when identifying established protocols within cloud applications, similar to recognizing protocols used in other applications. The best part is that OPC UA does not re-invent them. Instead, OPC UA can communicate via AMQP or MQTT, but also via WebSockets, like browser applications. These are use-case-specific protocol bindings. OPC UA uses the protocol that is most common and covers each respective use case. For example, an OPC UA Publisher can provide data to some middleware (typically a broker) where the Subscribers are able to pick it up. Furthermore, OPC UA can be used over MQTT for direct cloud connectivity.

**CLARK: So, have I correctly understood that, next to built-in security – which we will talk about in a separate article – scalability and re-use are two key elements of OPC UA?**

**STEINKRAUSS:** OPC UA has ONE information model which contains data plus metadata, (preferably standardized in companion specification). This model can be accessed via TWO mechanisms (Client-Server and Publish-Subscribe).

The access mechanisms use THREE (up to 5) transport protocols (which are selected according to the use case).

The continuity of OPC UA modeling, from the smallest sensor up to IT and Cloud applications, is one key element. The second key element is the re-use of established protocols, according to each use case.

OPC UA is based on Ethernet (encoded binary or JSON) and is transported natively with either UA-TCP and UDP, or MQTT, or WebSockets; all of which are well established open standards.

## ABOUT THE INTERVIEW PARTNER:

Uwe Steinkrauss is the CEO of company Unified Automation, based out of Nuremberg, Germany. Unified Automation offers Software Development Kits and Toolkits in all languages. Their customers use these Libraries to integrate OPC UA into their devices. Unified Automation's OPC UA tools and solutions have emerged from the very first day, back in 2006 when OPC UA was started. They are involved in the technical Working-Groups, Prototyping, Test- and Certification activities of the OPC Foundation. Unified Automation is driving the OPC UA standard forward and continuously contribute and support on marketing events, roadshows, fairs and tradeshows of the OPC Foundation.

## VIDEOS

1: Tech-Intro "OPC UA Concepts" by Uwe Steinkrauss (06-2019) 9:30 min <https://youtu.be/E2XJfmAEdqw>

2: Tech-Intro "OPC UA Transport" by Uwe Steinkrauss (06-2019) 17min <https://youtu.be/VCQnLly0cDY>

3: Tech-Intro "OPC UA Security" by Uwe Steinkrauss (06-2019) 11min <https://youtu.be/z4zNgNdauLY>

4: Tech-Intro "OPC UA Profiles" by Uwe Steinkrauss (06-2019) 8min <https://youtu.be/CCvILASACjE>

5: Tech-Intro "OPC UA Discovery" by Uwe Steinkrauss (06-2019) 6min <https://youtu.be/1NlbUAI0dcA>



**Peter Lutz**, Director - Field Level Communications,  
OPC Foundation North America  
[peter.lutz@opcfoundation.org](mailto:peter.lutz@opcfoundation.org)

## The Field Level Communications Initiative of the OPC Foundation

### IN THIS SECTION:

Peter Lutz, the Director of Field Level Communication at the OPC Foundation explains FLC's goals, the various parties involved, including committees and working groups. He will share relevant use cases and how FLC will adapt to upcoming trends and technologies.

**MICHAEL CLARK:** Peter, please introduce yourself to our readers and tell us about your involvement with OPC technology and the OPC Foundation.

**PETER LUTZ:** I live in the South of Germany, between Stuttgart and Munich. I was hired by the OPC Foundation in April 2019, to coordinate the FLC initiative as a full-time director.

My background is in industrial automation, open control systems, communication solutions, and international standardization. For more than 20 years, I was in charge of running the Sercos User Organization, developing and promoting an open, standardized, real-time communication solution for automation. In my previous job, I was already involved in some cooperative projects with the OPC Foundation. For example, together, we launched the Machinery Initiative back in 2011. We also started to work on an OPC UA Companion Specification for the Sercos Automation Bus, back in 2014.

**CLARK:** The OPC Foundation launched the Field Level Communication Initiative (FLC), in November, 2018. Can you provide some background on this initiative?

**LUTZ:** Certainly. As the name Field Level Communication already implies, the initiative is about bringing OPC UA down to the field level. The field level is the area closest to the production process and is typically understood as the interface between the control systems and the process itself. By extending OPC UA to the field level, it becomes a unified, open, communication solution that fully scales from field to cloud, and vice versa. In order to be successful with this approach, OPC UA has to be

extended with certain features and functions – motion, functional safety, determinism, among many others – to meet the diverse requirements for both factory and process automation.

**CLARK:** How is the initiative organized and what is the relationship to other committees and working groups across the OPC Foundation?

**LUTZ:** First of all, the technical work is performed by various FLC technical working groups. Currently, there are more than 200 active experts from over 60 member companies of the OPC Foundation. These groups work on the specifications; they ensure the technical feasibility of the extensions that I just mentioned. Furthermore, they have to make sure that the specifications and the technology are easy to use, and that interoperability is achieved across all vendor products.

We have also established a steering committee, comprised of 26 member companies; among them are the market leaders in industrial automation. These companies are bringing in additional financial contributions, additional manpower, and, very importantly, specific knowhow from 20 years of experience with fieldbus technologies. Additionally, they are responsible for identifying the requirements for the technical solution and defining the road map that guides the technical work, which, by the way, is open to all OPC Foundation members. I would like to mention that the steering committee is open to all interested companies who wish to participate.

Finally, one important aspect that I should mention is that the FLC steering committee is not acting independently, since it's a part of the OPC



Field Level Communications initiative of the OPC Foundation

Foundation. This steering committee is closely aligned with the OPC Foundation committees, including the Board of Directors, Marketing Control Board, and Technical Control Board. This is important to note, since we want to ensure a consistent, technical solution for all use cases across various industrial sectors.

**CLARK: Upon which use cases is FLC focused and how might this help extend any use cases that OPC UA is already covering today?**

**LUTZ:** If we look at OPC UA today, a lot of different use cases are very well addressed. Some examples include the connectivity between control systems; HMI, SCADA, MES and ERP systems; local OT communication; and, let's not forget, cloud connectivity. However, connectivity from control systems down to the field level, and connectivity between controllers – specifically pertaining to determinism – is not yet covered by OPC UA today. This is the area where connectivity to each variety of fieldbus is not well established, especially when it comes to determinism, functional

safety, motion, and remote IO.

FLC focuses on both controller to controller (C2C) use cases – horizontal integration – and controller to field device (C2D) use cases – vertical integration. We also include device to device use cases where field devices communicate directly with each other.

For all these different use cases, FLC is leveraging direct connectivity in order to support the vertical integration as well as full scalability across all communication levels, across all layers within the automation architecture, and beyond – even to the cloud. With this approach, OPC UA is a completely unique technology that provides consistency across IT & OT, which further supports convergence and harmonization for industrial automation in both discrete and continuous manufacturing.

**CLARK: What is the technical approach for FLC, and how will it be able to adapt to upcoming trends and technologies?**

**LUTZ:** First of all, it is important that FLC builds upon today's standardized OPC UA framework, IEC 62541, and, any extensions we create, are fully compatible with it. As I said before, FLC makes extensions, it is looking for those additional mechanisms which are needed to cover all the different types of automation components. For this purpose, different features are specified, including state machines, basic diagnostics, bootstrapping mechanisms, connection establishment, and, very importantly, offline engineering. In addition, semantics are specified for each type of automation component; we call this a facet. To give a few examples, we will develop a motion facet that covers motion devices; a safety facet to support the interaction of safety critical devices; and an IO facet for remote and distributed IO devices.

In addition to these facets, FLC goes further to define, so-called, profiles. This is when we define the mandatory facets for specific automation devices, which becomes the enabler for cross-vendor interoperability.

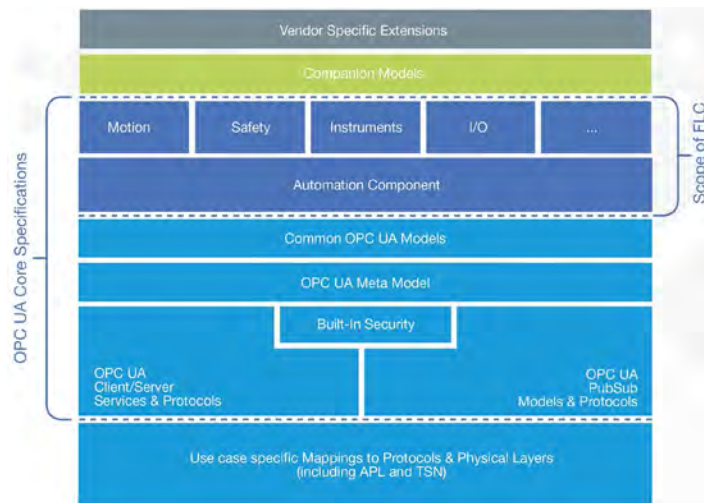

OPC UA FLC system architecture

**CLARK: FLC is often mentioned in the context of other technologies and standards, such as APL, TSN, 5G and Wi-Fi 6. Can you explain what role these technologies play and why APL & TSN are especially important to FLC?**

**LUTZ:** As I mentioned before, OPC UA is an industrial framework, which can be used in combination with different underlying transport systems and different transmission physics. The OPC Foundation and the FLC initiative are strongly committed to IEEE standards. This is where we find standards such as the Advanced Physical Layer (APL) as well as Time Sensitive Networking (TSN), which is the new generation of Ethernet, supporting deterministic transmission. FLC is making use of a specific “quality of service” model which allows us to easily adapt to different communications standards, including technologies such as 5G and Wi-Fi 6.

Since you asked, I want to specifically explain why APL and TSN standards are so important to FLC.

Time Sensitive Networking is enabling us to use Ethernet with deterministic characteristics. This is enabling the convergence of industrial networks because you can use Ethernet TSN as a common unified network infrastructure that can be shared by different communication protocols. Hence, in this case, we’re supporting OPC UA over TSN.

APL is the enabler for adopting Ethernet in the process industry. The Advanced Physical Layer provides seamless Ethernet connectivity, down to the field level, in combination with high bandwidth, intrinsic safety, and the ability to transmit both power and data over a single, shielded, twisted-pair cable. This is the enabling technology that brings OPC UA down to the field level within the process industry.

**CLARK: What does deterministic communication mean?**

**LUTZ:** Determinism is an essential feature when covering field communications. To control processes and production, it’s important to have deterministic behavior; you need to have application-specific cycle times covered; you have to reduce jitter to make sure the data is at the right place at the right time. This is where different standards come into play, allowing deterministic communication, which supports real-time applications.

**CLARK: Can you say that TSN provides built-in deterministic communication?**

**LUTZ:** Yes, it has mechanisms and features that support deterministic behavior of Ethernet communication. Nevertheless, since there are so many features defined by the TSN standard, FLC, in cooperation with other organizations who are adopting TSN, are striving to agree on a common profile, to ensure that we can use a common network infrastructure. This is the cooperative activity between the IEC and IEEE 60802 committee, who jointly work on this industrial automation profile for TSN.

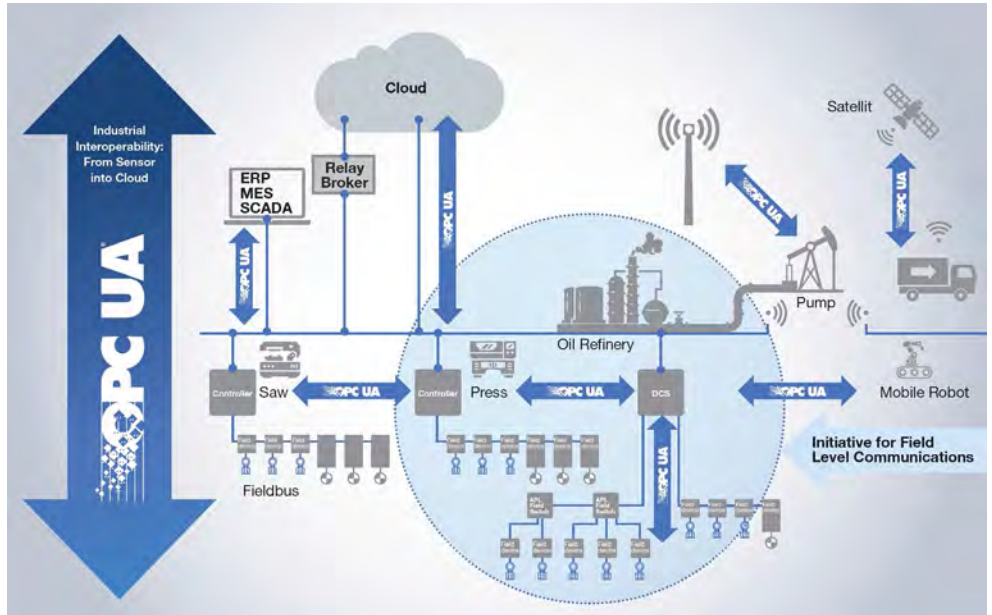

FLC interaction model

**CLARK: Can you explain how FLC is impacting the automation market and the world of industrial communication?**

**LUTZ:** The combination of OPC UA, with the extensions done by FLC, and the inclusion of TSN and APL standards, offers a complete, open, standardized, and interoperable solution. On the one hand, it covers requirements of industrial automation, but on the other, it is fully scalable from sensor to cloud. Not only is connectivity important, but I also want to highlight the semantic interoperability, which then provides “plug and play” capabilities.

By having one consistent communication solution, we will overcome many of today’s limitations due to a broad variety of fieldbuses. I would summarize that, if we combine the technical solution with the strong support that we have from all the major players in the automation industry, OPC UA FLC has the potential to become the universal industrial networking standard.

**CLARK: Does this mean that FLC is in competition with existing fieldbus systems like PROFINET?**

**LUTZ:** This question is a little difficult to answer. On one hand, there is competition, but on the other, it’s important to emphasize that the OPC UA solution is not replacing existing fieldbuses in, let’s say, a disruptive way. This will be a long-term process, with OPC UA and the various fieldbus technologies coexisting for many years.

I would also emphasize that we can expect that, within the next ten years, OPC UA, in combination with TSN and APL, will become one of the leading field communication solutions with growing market share. I want to further emphasize that both TSN and APL are protocol independent and, because of that, they are driving convergence and supporting migration from the existing ecosystems towards a common, global OPC UA-based ecosystem. Based on the involvement of those companies engaged in FLC initiatives, it is clear that this will be supported by the entire automation industry.



**CLARK: If I understand correctly, FLC is more of an evolutionary rather than revolutionary approach in relationship to existing fieldbuses.**

**LUTZ:** Yes; that is absolutely correct.

**CLARK: Can you share the FLC roadmap of when we might expect the first specification release and available products?**

**LUTZ:** Today, we have OPC UA solutions on the market from a large number of providers across a wide variety of applications. Additionally, we have OPC UA prototypes that include TSN. However, I want to emphasize that the specifications that really enable cross-vendor interoperability, those that combine TSN and APL communications between controllers of different vendors, between controllers and field devices, these specifications are still in development. Nevertheless, the release of the first specification, covering Controller to Controller (C2C) use cases, is immanent. Shortly thereafter, I would expect to see the first OPC UA products, those supporting FLC, sometime in 2021.

**CLARK: A moment ago, you stated that all the big players in factory and process automation are involved in the FLC initiative. What influence does this have on the development process and the pace of progress?**

**LUTZ:** First of all, I think it's really significant to highlight that all the big automation players are supporting the FLC initiative and that they are active in the different working groups. This is important because it really constitutes a solid foundation to develop a unified and worldwide standard that is finally being accepted by the entire industry. But, because of all the different interests and different backgrounds of all these major automation suppliers, the pace has not been extremely fast. On the other hand, I think that what is more important than short-term success is that we have sustainability and standardization. Overall, I want to highlight that it's really remarkable how constructive and harmonious the cooperation has been with all the different companies involved. This gives me a lot of optimism that we will come to a good solution that receives broad acceptance.

**CLARK: Are there mid-sized or small companies contributing to the working groups?**

**LUTZ:** Yes, we have different types of companies involved; in the technical working groups we especially see a lot of small and medium enterprises. Of course, we must include the major automation suppliers in order to achieve broad acceptance, but, since this is an open standard, it's attracting the smaller and the medium-sized companies to deliver their specific products into this vast ecosystem. Therefore, for overall success, we need to involve a broad variety of companies.

**CLARK: Which steps are being taken to achieve a high degree of interoperability?**

**LUTZ:** To support interoperability across all vendors and across various products, we have different elements for which we must take great care. First of all, I already mentioned the importance of the specifications that define all the essential interfaces and behaviors. This is the logical starting point, but then we have our prototyping working group, which currently

consists of more than 30 team members. They are taking great care to verify that the specifications are solid, complete, and that there are no ambiguities; this assures a high-quality standard.

In addition, we have established a special working group focused on creating test specifications, which are then converted to special test scripts for incorporation into the OPC Foundation's Compliance Test Tool (CTT). This is the testing software that vendors and the certification lab use for executing conformance testing.

**CLARK: In closing, do you have any final thoughts that you would like to share with our readers?**

**LUTZ:** As a final thought, perhaps I can share a question that a journalist recently asked me. He wanted to understand what is so unique about FLC. When I thought about it, I came to the conclusion that it's a once in a lifetime chance to really drive harmonization; to help develop one common ecosystem for the whole industry; one that is getting support from the largest automation suppliers to the smallest enterprises. The reason I call it a once in a lifetime chance is that we are taking OPC UA as a well-established industrial standard, and combining it with other technologies coming out of IEC/IEEE. I believe that now is the time to move away from proprietary, closed ecosystems. The FLC work will serve to harmonize and converge on a consistent, worldwide standard. This is exciting to me.

---

#### **ABOUT THE INTERVIEW PARTNER:**

Peter Lutz is director field level communications of the OPC Foundation. He has more than 25 years of experience in open control systems, industrial automation, and real-time communications. He has been engaged in several national and international standardization committees, including IEC SC65C (digital communication), IEC SC22G (adjustable speed electric drive systems), and IEC/IEEE 60802 WG (TSN Profile for industrial automation). Since April 2019, he has been managing the OPC Foundation's FLC initiative with the goal of establishing OPC UA as a globally accepted standard for field level communications in the factory and process industries.

#### **VIDEOS:**

[www.opcfoundation.org/FLC](http://www.opcfoundation.org/FLC)

[www.opcfoundation.org/APL](http://www.opcfoundation.org/APL)

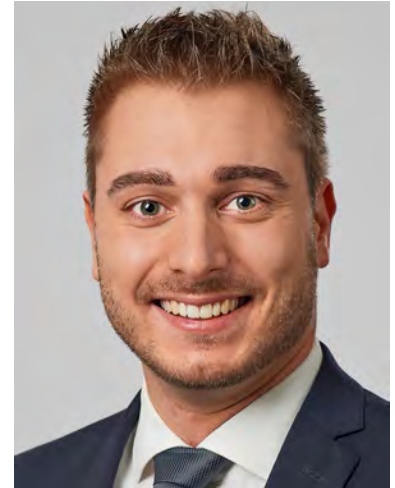

**Andreas Faath**, OPC UA for VDMA  
[andreas.faath@vdma.org](mailto:andreas.faath@vdma.org)

## VDMA Companion Specifications

### IN THIS SECTION:

Learn from an interview with Andreas Faath about OPC UA Companion Specifications coordinated by the Mechanical Engineering Industry Association (VDMA). Andreas will describe the role of VDMA and companies involved in the unique process of developing companion specifications, the contents of these standards, and how you can become involved.

**MICHAEL CLARK: Andreas, please introduce yourself to our readers and tell us a bit about your employer, the Mechanical Engineering Industry Association (VDMA), and your involvement with OPC technology and the OPC Foundation.**

**ANDREAS FAATH:** My name is Andreas Faath, Head of Interoperability, and I am leading the work of OPC UA within the VDMA. The VDMA is the most important industrial association across Europe in the field of mechanical engineering. We have more than 3300 member-companies from a broad range of the manufacturing industries. To do that we have thirty-eight trade associations and a lot of regional and global subsidiaries, like China, Japan, India, Russia, Brazil, and Brussels supporting our work.

The VDMA was not looking, specifically, for OPC UA technology in the beginning, but we were searching for technology that would help us standardize interfaces. Standardized interfaces are a genuine need throughout the mechanical industry. For this purpose, we searched for a technology which is secure and which is scalable from the shop floor up to the cloud. To that end, we found OPC UA.

**CLARK: What is the status of OPC UA in mechanical engineering? Do other, competing standards exist? Or has OPC UA established itself as the de-facto standard for industrial interoperability?**

**FAATH:** I would say that OPC UA is a de-facto standard. Because of this, the working groups are seriously engaged in developing OPC UA companion specifications. Within these working groups, there no longer remains any question as to whether we should use OPC UA. They're



building on the foundation of OPC UA to describe their standardized interfaces.

**CLARK: What is the process for developing OPC UA Companion Specifications within VDMA? How do you go about getting companies and their representatives together around one table? Are there any legal implications?**

**FAATH:** We have a great five-step process, which we have improved over several years.

As part of the first step, we invite companies to become involved in a relevant working group. On the one hand, we start by asking our VDMA members to identify needs and to investigate whether they wish to develop a companion specification on a particular topic. On the other hand, with assistance from the OPC Foundation, we perform research across the global community, asking volunteers whether they have the same idea as our members. This is how we have formed a critical mass of companies behind each of these standards – to help drive the standards and to encourage worldwide adoption.

The second step is to have each of the participants – those who represent the various machine types that are to be included in the standard – begin development of the content. That means that domain expertise is required to determine what information should be included in each respective companion specification.

Since step two is primarily about collecting domain knowledge, step three focuses on transferring this information into OPC UA information models. This is a time when a lot of discussion comes up; how to develop; how to model; how to bring the information model to life; and to do all of this in a way where users can implement the standard with no possibility of misinterpretation.

Our fourth step is to publish the standards. This, also, is a process we have developed over many years. The Standards are known as VDMA-Specifications and their process has been driven by compliance to rules which are also used by DIN, ISO, and so on. In addition, we publish the specifications as OPC Foundation Standards. That means there are two identical Standards with only a different front page.

The fifth, is one of the most important steps. We support our members as they develop implementations of these new OPC UA companion specifications. Of course, our goal is to see these standards adopted among our members and throughout industry. Many of the companies involved in the working groups are incorporating the standards, outlined in the companion specifications, into their products and machines. Similarly, we host a lot of demonstrations where we show proof-of-concept implementations that confirm our companion specifications are working well and are easy to use.

**CLARK: Does VDMA, alone, drive these OPC UA Companion Specifications, or do partner organizations also get involved?**

**FAATH:** Of course, VDMA is not alone in this work. I will not name all of the partners because it would be a really long list, but I will highlight two

or three. For example, you have EUROMAP, the European plastics and rubber machinery manufacturers. Another one you might know is EUMABOIS, which oversees woodworking technologies.

These European and global associations, and their members, support many of the working groups, bringing together a critical mass of companies behind each standard.

I'd like to give one more example, which is an international example, called G3. This is an association of machine-vision manufacturers. This group started from scratch under the umbrella of the G3 Association. Their membership includes, Advancing Vision + Imaging (AIA), from the USA; European Machine Vision Association (EMVA); Japan Industrial Imaging Association (JIIA); China Machine Vision Union (CMVU); and VDMA Machine Vision (VDMA MV). You can see that it's truly a global working group, including more than sixty companies and over one-hundred participants. This is really a great, great group for international collaboration.

And, of course, we have one more obvious partner called the OPC Foundation, who you all know. The VDMA and OPC Foundation are working very closely together, promoting our companion specifications worldwide. All of the VDMA working groups are also joint working groups within the OPC Foundation. We include the members of OPC Foundation throughout our entire development process.

**CLARK: Can you give us an overview of the OPC UA Companion Specification working groups that exist at VDMA and a status of their progress?**

**FAATH:** At the moment, we have more than 600 companies involved in more than 35 working groups. I cannot do a deep dive into all of them, but I will give you a short overview and, perhaps, I can highlight one or two. All of the groups and the latest-and-greatest news can be found on [opcua.vdma.org](http://opcua.vdma.org).

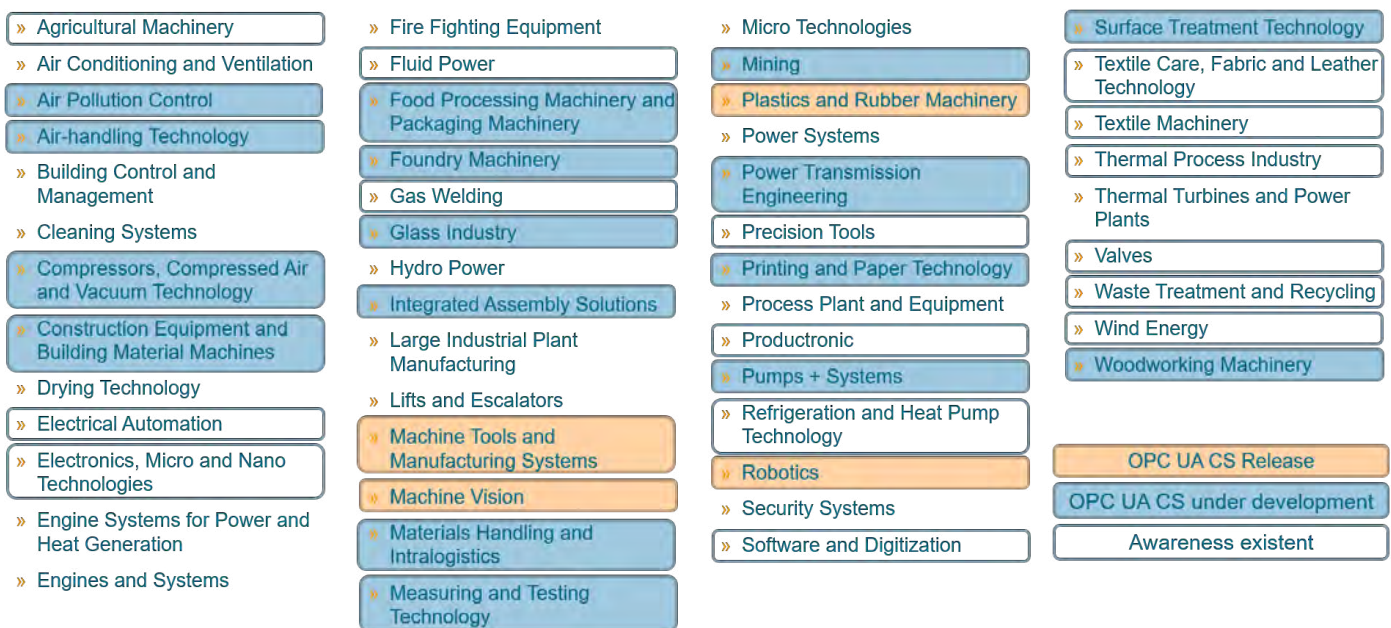

Overview of OPC UA Companion Specification Working Groups.

We have working groups for additive manufacturing, air pollution control; we have automated/guided vehicles; we have compressors/compressed air and vacuum technology; we have industry cranes, which are working closely together with robotics because they share coordinate systems and movements; we have food processing and packaging machinery, which is translating the existing Weihenstephan Standard (communication interfaces for machine data acquisition) into an OPC UA Companion Specification; we have foundry machinery working together with CEMA-FON; we have glass machinery; we have integrated assembly solutions, which are developing standards for end of arm tools, including grippers, which are part of this group; we have intralogistics systems; we have Laser Technology; we have length measurement technology; we have machine tools and manufacturing systems; we have machine vision working together with G3, having a behavior and status machine driven approach; we have mining together with IRIDES; we have plastics and rubber machinery, together with EUROMAP, which, consequently, is one of the first groups to start creating companion specifications; we have power transmission engineering; we have printing and paper technology; we have pumps and systems; we have robotics, which incorporates motion devices; and, to wrap up the list, we have surface technology, textile machinery, weighing technology, and woodworking machinery. I am pretty sure I have forgotten a few.

You can see that it's a broad range of the manufacturing industries that we are covering. This is also representative of our working groups, which are interacting together very well.

**CLARK: How long does it typically take to produce an OPC UA Companion Specification?**

**FAATH:** Well, this is not really a rule, but, normally, we see about two years from the beginning of authoring to the final release in the market. Sometimes it takes longer, sometimes the group is a little bit faster; it really depends on the clarity of the vision and how easily they can find their stride to achieve their goals. For example, groups who are now doing their second companion specification, like the robotic group, will be much faster than those who just started and are not really aware of how to be efficient.

**CLARK: What are the deliverables from a working group; what can I read and see?**

**FAATH:** What we have, in the end, are two things: We have a human readable document (.pdf), where one can find all the information, all the descriptions of the information, everything you need to know for implementation. On the other hand, we have an .xml file, which is machine readable and which will be implemented using the guidance outlined in the documentation. So, ultimately, you need both – on one hand, to understand the standard, and, on the other, to implement the .xml file.

**CLARK: Are the resulting OPC UA Companion Specifications shared between VDMA and OPC Foundation? Are they recognized as international standards?**

**FAATH:** Each VDMA Specification are identical to the corresponding OPC Foundation Companion Specification. Both standards reference one another; the only difference being the first page, with the body of

each standard having identical content. The VDMA Specification has obvious recognition across Europe, while the OPC Foundation version, generally speaking, finds a much wider audience, internationally.

**CLARK: How about harmonization between the range of OPC UA Companion Specifications? Does VDMA engage in harmonization activities amongst the different specifications?**

**FAATH:** This is one of the more challenging tasks the VDMA has to fulfill. We're working in partnership with the OPC Foundation's Harmonization Working Group, where we bring our needs from the mechanical engineering industry. Additionally, we have a VDMA harmonization group called OPC UA for Machinery. Within this group, we define information from the perspective of the mechanical engineering industry, which differs from that of the process industry. Not only are we addressing the VDMA needs, but, by working together with the OPC Foundation Harmonization Working Group, we are assisting the process industry. This ensures that end users have the benefit of a much bigger picture – they are provided with standards that cover various industrial sectors, but the specifications are described in a similar way. We have already released the first Part of the OPC UA for Machinery.

**CLARK: Do you consider VDMA as an OPC UA interoperability hub for Mechanical Engineering within Germany, perhaps across Europe, or is it, instead, global in nature?**

**FAATH:** We are striving to be the hub for companion specifications in the field of mechanical engineering. This is a global approach and we're trying to include domain knowledge, from all over the world, within our working groups. The big goal, really, is that any interested parties, regardless of geographical location, who are thinking about creating an OPC UA Companion Specification in the field of mechanical engineering, get in contact with us. We can first see if there's a working group that they can join that's already active on their particular topic of interest or if, perhaps, a new group needs to be created. The tragedy we are hoping to avoid is seeing disconnected groups, across the globe, working on parallel standards in isolation. This is the worst case, and we are striving to avoid it.

**CLARK: What does the VDMA have planned for driving and coordinating OPC UA Companion Specifications for the coming years? Are you almost done? Or are you still open for new companies and our readers to get involved?**

**FAATH:** This is a question I hear quite often. The clear answer is, no, we are not almost done. In fact, we are launching new groups almost every month. We are growing and growing and growing. If I look back, we have triple the number of working groups that we had in 2017. It's growing very rapidly. It's not like we're waiting around for a group to start doing an OPC UA Companion Specification. Rather, they're actively coming to us and asking, "how can we get started? what do we need to do? how can we get in touch with the VDMA? how can we join a group?"

Additionally, our members come to us saying, "come on; let's do a companion specification! We have a need defined by our customers who are also asking about standards".

So, as I said, we're not almost done; however, we can announce that some of the working groups have finished the first release of their companion specification and are now starting on the second part. It's encouraging to see how each of the member companies are willing to participate and bring the standards to the market.

**CLARK: In closing, is there any activity or developments that you have seen lately that you would like to share with our readers?**

**FAATH:** Yes, there are two things; the first is one that I just mentioned, but I'd like to reiterate that, as we create more and more working groups, we are becoming more efficient. For us, it is pretty important that, if there are interested parties, anywhere in the world, who are considering creating companion specifications, that they take the opportunity to get in touch with us. We are pleased that this happens quite often and it's working very well, but I never get tired of offering the invitation again and again. Please collaborate; collaborate with the VDMA because we are eager to collaborate with you. There should be no barriers; it would be really great to get in touch, especially if there are intentions to create companion specifications within the mechanical engineering industry.

The second activity that I'd like to share is that we have hosted events within the VDMA, the last one had about 200 people in the room (pre-Coronavirus). It was a meeting of the OPC UA Working Groups inside the

VDMA. We had a very broad range of people in the room who were driving the standards, in their respective fields, throughout the mechanical engineering industry. Everyone was able to network and see how other groups are doing, where certain problems exist, and how they are being solved. This was an example of what we want to do and where we want to go; to provide a platform for discussion, for networking, for coming together, and, of course, creating OPC UA Companion Specifications for the mechanical engineering industry. There are many future events where you can participate and learn about the OPC UA Companion Specifications of the mechanical engineering industry. All events are announced and open for registration on [opcua.vdma.org](http://opcua.vdma.org).

**ABOUT THE INTERVIEW PARTNER:**

Andreas Faath is head of OPC UA for VDMA, Germany's Mechanical Engineering Industry Association. VDMA represents around 3,300 member companies in the SME-dominated mechanical and systems engineering industry in Germany and Europe.



The Industrial Interoperability Standard

[www.opcfoundation.org](http://www.opcfoundation.org)

# OPC UA: The Framework for Industrial Interoperability

- Modeling of data and interfaces for devices and services
- Integrated security by design with configurable access rights for data and services – validated by German BSI security experts
- Extendable transport protocols:  
Client/Server and Publisher/Subscriber and roadmap for TSN/5G
- Scalable from sensor to IT Enterprise & Cloud
- Independent from vendor, operating system, implementation language and vertical markets

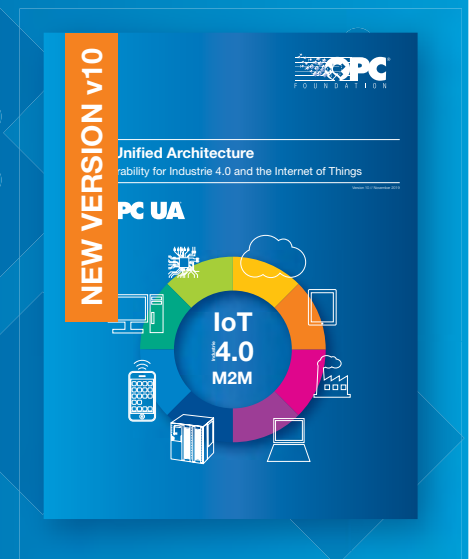



**Marcel de Grutter**, Executive Director & Member of the Steering Committee, OPEN-SCS Working Group  
[marcel.degrutter@abbott.com](mailto:marcel.degrutter@abbott.com)

## OPEN Serialization Communication Standard

**IN THIS SECTION:** Marcel de Grutter of Abbott Healthcare in his role as Executive Director of the OPEN-SCS Working Group describes OPEN-SCS, the OPEN Serialization Communication Standard. He will explain the purpose of OPEN-SCS, what serialization means, what developments have been driven forward in this area by COVID-19, and the role OPC-UA plays as the base communication architecture. .

**MICHAEL CLARK:** Marcel, please introduce yourself to our readers and tell us about Abbott, your role with the OPEN-SCS, and your involvement with OPC technology and the OPC Foundation.

**MARCEL DE GRUTTER:** My name is Marcel de Grutter and I am based in the Netherlands. My career spans more than thirty-two years within the Pharmaceutical industry; always for the same company, but in many different roles. I have headed operational departments, but I was also the head of IT, where I was involved in implementing manufacturing execution systems (MES), as well as the roll out of SAP, which is our ERP system. For a time, I was also responsible for quality systems inside Abbott. For the last few years, I've been concentrating on serialization, where I currently have the role of Regulatory and Government Affairs Liaison. This is where I build connections between authorities and regulatory affairs departments within Abbott.

**CLARK:** OPEN-SCS stands for OPEN Serialization Communication Standard. Can you please explain what serialization means and where it's used?

**DE GRUTTER:** Before we talk about serialization, we have to address why this is needed. There are a lot of substandard, unregistered, unlicensed, or falsified medicine products that are going around in the world – and a lot of people are dying because of this.

Let me explain what these terms mean. Substandard means that the products are out of specification or that they do not meet the quality standards that are implied.

Falsified means medical products that are deliberately or fraudulently misrepresented or identified; or that the purported source of the medica-

tion is not the actual source from whence the product originates.

Unregistered, or unlicensed, medical products are those that have not undergone the proper evaluation necessary for the product to be released to the market. According to the World Health Organization, WHO, in low- and middle-income countries, they have found that 10.5% of the products are, in fact, leading to many issues – including deaths.

Yearly, between 72,000 and 196,000 deaths of children under 15 years of age, are caused by substandard and falsified antibiotics. Between 31,000 and 116,000 deaths are caused by substandard and falsified antimalarial drugs in sub-Saharan Africa.

Even now, with the COVID-19 pandemic, you see a lot of counterfeit products, including masks and other products that have a classification – like FFP2 for mouth masks – but are not properly classified. The regulatory bodies have to do something to protect us. This is why a lot of regulators, around the world, are coming up with a track-and-trace system for pharmaceutical products.

One of the ways to do track-and-trace is through serialization. This means that every product unit gets its own serial number. For example, this is different than scanning a product code on something like a can of Coca-Cola. Through serialization, what we are effectively doing is adding a unique unit number for each can. As part of these new regulations, pharmaceutical companies are required to serialize their products so that substandard or falsified drugs can be identified and, depending on the system implemented, authenticated. We can then perform track-and-trace monitoring to see if counterfeit products are entering the supply-chain.

For example, when a pharmacist is dispensing a particular unit, the pharmacist scans the barcode, the code is then flagged in the system so that same unit cannot be sold anywhere else. So, if somebody else tries to sell a counterfeit product with a duplicate barcode at another location, the system will produce warnings.

To do this efficiently across the supply chain, we also do aggregation. This means that we are connecting carton labels, associated with each product-unit inside that carton, and then each carton is linked to its respective pallet. So, the supply-chain people can scan a box or pallet and they know which units are inside.

**CLARK: Where does OPEN-SCS fit into those developments?**

**DE GRUTTER:** First of all, you have to understand how companies typically classify their investments. They generally can be classified into three categories: systems of innovation, systems to support the business processes, and systems of regulatory compliance. Because serialization used to be seen only as a tool in regulatory compliance, companies only invested what was mandated. In the early stages of implementing serialization, it was merely seen as a license to sell. Companies were seeing how quickly they could implement these requirements in order to comply with the basic regulations.

Companies coming from other business sectors saw this as an opportunity, even though they had no knowledge of the pharmaceutical requirements. In pharmaceuticals, you have high demands to validate systems, to ensure data integrity, safety, and that the system is really doing what it was developed to do. In many implementations, this was taken into account because it's normal in pharma, but it didn't get the attention in needed when it came to security. Vendors, and specialist from within pharmaceutical companies, were implementing systems at their own level of expertise, neither thinking about the future nor how the data of serialization might be used for other purposes.

Five years ago, there was an event organized by Optel in Frankfurt, Germany, where 85 subject matter experts came together to discuss integration issues that, at that time, they were concerned about. They found that there is a big need for standardization of interfaces between different layers, so that Company X can easily interface with Company Y. Until now, developing these kinds of interfaces were completely new projects. This should not be the case, because it's time consuming and very costly. They also saw that customers and vendors were speaking different languages. Implementations were done with vast customizations, which lead to data integrity issues and, again, high costs. This becomes a barrier to future innovations.

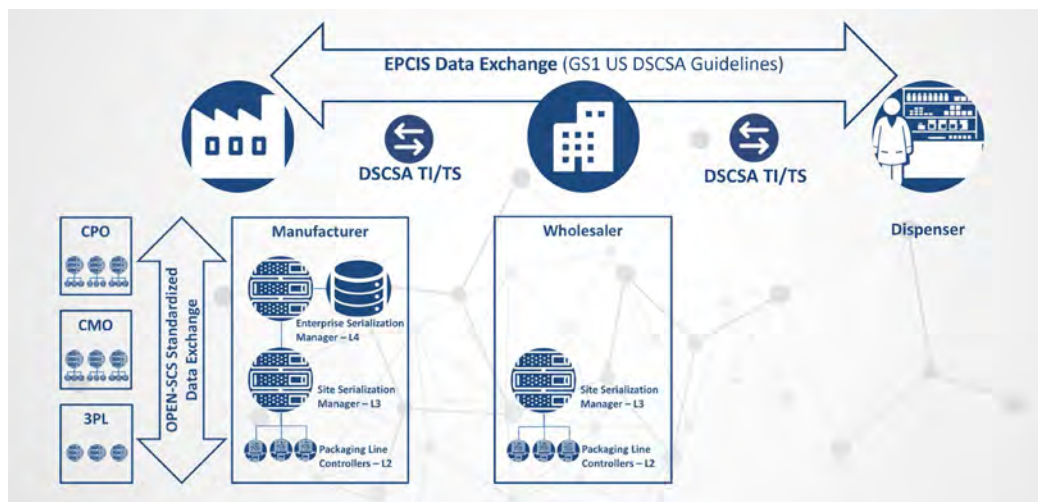

Serialization data exchange.

**CLARK: What have been the main challenges?**

**DE GRUTTER:** Because regulatory bodies wanted to respond quickly, in order to prevent people from dying, the timelines to implement serialization were very short. They underestimated the requirements to implement such systems. For example, they failed to prepare for the huge amount of data that is generated by these systems; there was no preparation to capture and store the data securely, away from hackers. The companies that were implementing these systems were focused only on meeting the deadlines; if they didn't, they could not sell their products.

Now, let's address the challenges with people speaking different languages. It was a struggle to understand what should be implemented and how to implement it. Regulators have been publishing regulatory requirements, but without detailed specifications. They state that a company only has to do "this," but they provide no reasons why, or what they have to report, or how it gets reported.

Then, when it came to connecting the various systems, furnished by different vendors, many of the sales people were using nice presentation slides, introducing things like the ISA 95 model, but if you asked them to go into any depth, they really didn't understand what it meant. There was a lack of understanding as to how to use the existing standards, like OPC UA, ISA 95, as well as GS1. That was a big challenge for us.

We also saw that the vendors wanted to sell full-blown solutions, covering all layers, not taking into account the requirements in pharma. For example, most pharmaceutical companies work with lots of third-party manufacturers. Serialization data is to be shared with a lot of different parties across a wide array of systems. That's very difficult. We observed that the current systems had been created for "developed" countries, but to implement them in emerging countries would be a big challenge due to the enormous work to maintain them, and the cost associated. That's why we decided that a new standard or new way of thinking was necessary.

**CLARK: May I assume that digital transformation of health care is going to address those challenges? How would Serialization and OPEN-SCS fit in?**

**DE GRUTTER:** Let me share several examples.

Serial-numbers are applied to the packaging of a drug using the GS1 DataMatrix, a two-dimensional barcode, which contains the GTIN, Expiry Date, Lot Number, and Serial Number. Events – the what, where, when and why – are communicated using GS1 EPC-IS. This information can help a lot in a hospital. For example, when nurses are dispensing products, not only can the product itself be protected, but it's clear whether the product has expired or not, or if it is the correct dosage. So, applying a searchable barcode is very helpful.

When looking to the future, we envision that patients will be able to scan a particular product's barcode, directing them to an online menu, where they can select an E-leaflet, providing the patient with the latest information about that product, and eliminating the need for paper copies which may not be up to date.

Advancing this idea further, some medical devices are sometimes hard to use due to their complexity. By scanning the DataMatrix barcode, we can direct the patient to a video, providing instructions as to how the product should be used.

Even though our initial intentions were to protect patients from substandard and falsified drugs, we see the opportunity to improve drug recalls. In the past, an entire batch had to be recalled from the market when there was an issue with that drug. Now, we can clearly and specifically identify which units are affected, and we can easily assure that these flawed products will never be sold.

Let's consider drug-interaction checking. If a patient was using a certain type of medication and then scans a newly prescribed medication, the system could say, "there is an interaction between this other product; you should be careful not to take it." We can even use this system to track stolen or misused products.

You may have heard about smart packaging; there's a lot of noise around this topic. Packaging firms are now working on connecting packaging with the digital world. To enable these developments in the supply chain world, it requires robust, trustable, and safe integration between the manufacturing systems, so these systems can provide information to the enterprise system, the supply chain, as well as the manufacturing execution systems.

Think about laboratory settings. There is a tendency in pharma to work with centralized laboratories which have specific capabilities. So, as part of the care of custody, pertaining to samples that are sent to them, they have cold stream systems to detect if the sample was out of the refrigerator.

A lot of these functions are not only in the supply chain, but also on the manufacturing side. This means that, besides what GS1 is covering on the supply chain, with EPC-IS in the horizontal integration, we also need vertical integration, and this is where OPC UA and OPEN-SCS comes into place.

**CLARK: In times of COVID-19, what do you believe will be the effect, if any, on regulations? What resulting developments do you see?**

**DE GRUTTER:** I think there will be a huge shift in thinking within companies, as well as regulatory bodies, where, in the past, the focus centered around cost, quality, and delivery. Now, with COVID-19, it is clear that resilience, responsiveness, reconfigurability, and security are most important. This requires a completely different way of thinking. It is possible to implement a system for serialization, but if hackers breach the system's security and change serial numbers, or perhaps misappropriate those serial numbers, or even block products from coming to the market, that is a big issue; especially in this new world of COVID-19.

Pharma is a global business. Perhaps 80% of mouth-masks are manufactured in China, including a lot of other pharmaceutical products. Most drugs today are manufactured in China and India.

With the advent of remote working, due to COVID-19, digital transformation will get a boost, accelerating our thinking in ways of producing products, while doing things remotely.

Counterfeits, at the same time have ruthlessly increased because criminals are making use of the situation. People just want a mouth-mask; they don't care, or are perhaps not aware, that you can buy a substandard, ineffective, counterfeit mask.

The departments in which my family are working, within their respective hospitals, have stated that, by using a barcode, errors can be greatly reduced, especially in the stressful situations in which our nurses now find themselves; they have a lot of stress and a lot of patients. By applying barcodes to a product, which includes all the data I've outlined earlier, this kind of serialization can help them a lot.

Even if countries are considering de-globalization, what does that mean to globalized standards? My opinion is that, even if your country chooses a localization approach, applying global standards will still be extremely important, otherwise, you will likely see companies going bankrupt. If you have highly customized systems, how are you going to locally support that? In contrast, if you are using open, global standards, there are far more resources available to maintain those systems.

**CLARK: What is the mission and scope of the OPEN Serialization Communication Standard?**

**DE GRUTTER:** We are specifying functional interoperability and packaging serialization solutions because we want to have a seamless integration of operations and business processes across entire organizations but also regulatory bodies. We are also aligning with other industry groups and standards.

We are specifying the interfaces that are used for the vertical exchange of serial numbers and all the data that is required for the serialization process. We know there are existing standards for horizontal communication, like GS1 with EPC-IS, but we are focused on the vertical integration of systems. For those people with more knowledge about it, I'm talking about layers two, three and four. These systems can be in the same factory, but they could also reside with a third-party manufacturer. For example, many Layer 3 systems, used within manufacturing, are required to be connected with the enterprise systems of multinationals. This requires integration and, whether you like it or not, we will need to connect with different vendors and systems.

There will be even more vendors coming forward, because serialization is now part of emerging markets. We first implemented serialization in Ar-



gentina; then Turkey came along, followed by Europe. The US is starting now and the emerging markets are coming up. Advancements are not limited to the manufacturing area. Packaging operations across distribution centers are rapidly progressing. Many of these centers are not yet tasked because, currently, the serialization systems are focused on track-and-trace from the manufacturer to the patient, but not the systems in between. In other words, the distribution centers and the wholesalers are not in alignment yet. Packaging operations will need systems that support de-aggregation and aggregation of serial numbers. This will require integration of distribution systems with vertical systems.

**CLARK: Should our readers consider OPEN-SCS as a brand-new standard for serialization?**

**DE GRUTTER:** Yes and no. I'd like to make it clear that we are not replacing any existing standard, especially since this is a misinterpreted conclusion of some people. It's more an "add on" specification that describes how to use existing standards correctly; standards like OPC UA, EPC-IS, ISA95, and ISA88. We are describing how to use, model, and configure those interfaces in a consistent way. This is to ensure that the different parties are talking the same language and understand what it means. We see that some systems use data in a particular way and, when those systems deliver that data to external systems, users are disappointed when that data is not consumed in the same way it was exported. This can lead to data integrity issues.

We are not replacing or modifying existing standards, but where necessary, we extend them to provide the functionalities that we need. We are also ensuring that new serialization systems will not be haphazardly put on top of current business processes, but that they are integrated with the operations and systems that we already have.

For example, we are working very closely with GS1 to ensure that the data models that we are building are completely compliant with the EPC-IS model, preventing conflict with the GS1 standard. This means that we can easily interface the system from layer three with layer four and everybody, within that space, is talking the same language; we don't need to build conversion tables to convert data. Furthermore, our teams include experts in ISA95, who know how those systems work, and how to model the data in order to connect the interfaces of two different systems across different layers.

**CLARK: Why did OPEN-SCS choose OPC-UA as its underlying communication architecture?**

**DE GRUTTER:** OPC is already widely used in manufacturing operation systems, and now it's becoming more and more prolific at the enterprise

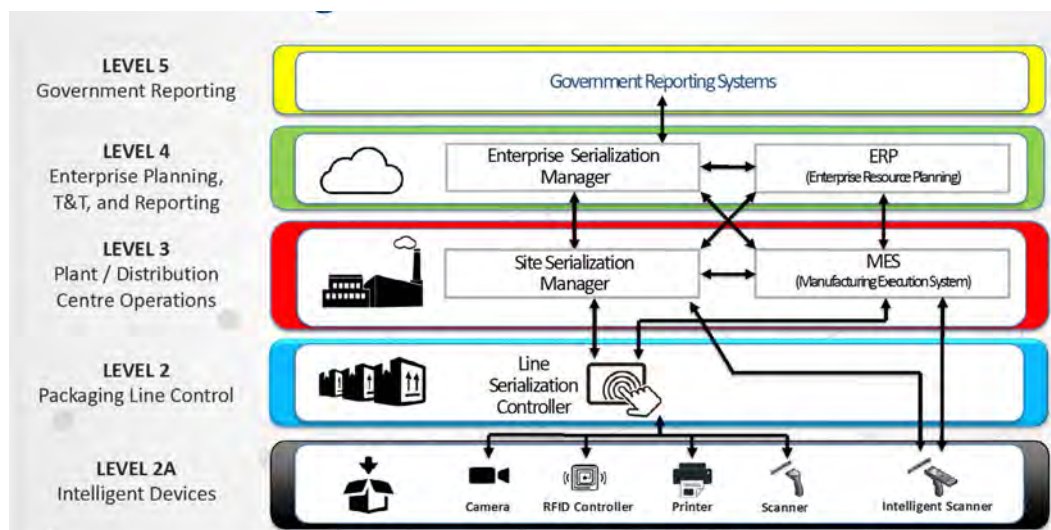

Manufacturing serialization information flow.

layer. We can support digital transformation, using a communication technology that allows vendor-independent, secure, transmission of structured serialization information into production packaging systems. It's an open standard, freely available and implementable under the GPL 2.0 license, rather than a technology from a certain vendor. It's a service-oriented architecture.

It has robust security, which is an important point that I want to stress, since I see a lot of issues with certain implementations. In many cases, companies are relying on their own in-house security, but I have detected many issues with these arrangements, especially since we have witnessed that counterfeits are created and brought to the market due to insider information; intellectual property stolen by people working within the company. There's so much money to gain from it.

OPC UA focuses on communication with industrial equipment, including systems for data collection and control. What is also very nice is that it's cross-platform; it's not tied to one operating system or programming language. I have had experience with OPC UA, long before beginning my work on serialization, when we integrated laboratory systems directly with operations. It is very, very powerful.

**CLARK: How is OPEN-SCS organized and what is the relationship with the OPC Foundation?**

**DE GRUTTER:** The OPC Foundation is acting as the host for the OPEN-SCS initiative and we are working as an OPC Foundation Working Group. The nice thing is that the OPEN-SCS group members are providing extra funding and the steering committee runs independently of the OPC Foundation. For example, we are hiring full-time subject matter experts with funds provided by our members.

Our membership and administrative processes, including our website, are handled and supported by the OPC Foundation, so we do not have to establish all kinds of procedures or legal structures.

We have 22 members, comprised of 3 pharmaceutical companies and 19 vendors and consultancy firms. Our steering committee has 11 members. I am the executive director of the OPEN-SCS, and it's important to me that I clearly state that what I'm speaking about today is on behalf of OPEN-SCS; I'm not speaking as an employee of Abbott. Mike Bryant

is our OPEN-SCS operations director and our secretary, with Thomas Halfmann as our marketing director. Cos Pipero is our subject matter expert on OPC UA, with Dennis Brandl as our technical director. I think it's also important to mention that we are fully operating under the bylaws of the OPC Foundation.

**CLARK: When can we expect products on the market using the OPEN-SCS specifications?**

**DE GRUTTER:** Version 1.0 of the specification has been published, which covers serial number exchange, but some vendors pointed out that, in order to implement a useful and fully working solution, master data exchange was essential. Therefore, we very quickly finalized Version 2.0 of the packaging specification. It is currently under review by our members and we are working on the OPC UA companion specification to offer those functionalities as we speak. Now it's up to the market to implement it, because the specifications are ready.

We see some reluctance to do implementations because it's a chicken and egg story; it's about who's willing to lead out to take some risks. The vendors are waiting on the customers and customers are waiting on the vendors, like always. Constant changes in markets and regulations don't help much, either. But the fact is that we are still missing global standards, and the systems in place are very expensive to maintain.

I'm not talking about specific implementations that existed before serialization, but now, after unlocking the benefits of serialization, integration will be the next question. How do we integrate? What can we do in a safe and robust way, in an obtainable way, using our existing systems?

We have implemented serialization, but have only protected a small part of the world's population against substandard and falsified drugs. We have not gotten to the areas where the effects of falsified medications are the highest, so we need to have a more holistic scope.

COVID-19 showed us that both local and remote support will be required, and that different systems in different countries will need to be integrated to use the best of breed. They must be affordable, given the economics in which we are implementing them. It's important for us to remember that we cannot implement a Mercedes or Ferrari in an emerging country where we just need a car that gets us from A to B; we need to think about what the needs and requirements are, and what we can afford to implement in those emerging countries.

Let's be honest, it's not that sexy to work on standardization, but maybe that will now change. Before COVID-19, it was not easy to motivate our management to invest. I don't wish this on anybody, but if companies are hit by catastrophe – and I'm not only talking about COVID-19 – if a company's systems are hacked, preventing shipment of products, or you discover that you are hampered in your developments because you have not standardized, then you have created your own catastrophe. It's not coming from outside, but rather from inside. Whatever the case may be, I'm still promoting and believing that OPEN-SCS is the right way to go.

**CLARK: Where can our readers find further information on the detailed OPEN-SCS specifications?**

**DE GRUTTER:** On our own website, [www.open-scs.org](http://www.open-scs.org). Also, there are some nice videos on YouTube; just search OPEN-SCS.

**CLARK: In closing, do you have any final thoughts that you would like to share with our readers?**

**DE GRUTTER:** Currently we are working with a small team to finalize Version 2.0; however, we need companies to start asking vendors to implement these standards, and for vendors to step up and take some risks to deliver products to the market.

To create awareness, we have recorded some training sessions; the first session, done by Dennis Brandl, is now posted on YouTube. He gives training on the basics of our standard – the packaging specification. This session will be followed up by live demos by Cos Pipero, showing the use of the specification and how to build products yourself.

We have built a virtual environment, with fourteen different virtual machines, that we can use for these demos. We maintain these so that our members can test their developments against each other.

Our technical team is working hard; they have bi-weekly meetings to finalize the specifications. It's a small team lead by Cos Pipero, but they are extremely motivated and knowledgeable. Craig Allan Repac, from GS1, is also attending these meetings.

I want to take this opportunity to thank those individuals who are active on the team, especially since they are not seen at the front, but, in fact, they are the ones making things work. I also want to encourage the vendors to support all those who spend a lot of time on these developments.

I would also like to thank those companies who continue to support us in our long and difficult journey, and who intend on developing implementations. That is what counts! We need products on the market; it's not a paper-based exercise, or a marketing exercise. We really need to make this a success in order to protect people's lives, and create a better health care system.

---

**ABOUT THE INTERVIEW PARTNER:**

**Marcel de Grutter - Executive Director OPEN-SCS**  
Based and raised in the Netherlands but working around the globe.  
With over 32 years' experience in pharmaceuticals, Marcel has held various positions and roles across the organization. His current position in Abbott is Liaison Regulatory & Government Affairs.

As a world-renowned and respected expert in MOMS, Operations, IT, Serialization Track & Trace he can translate regulatory and business requirements to practical, cost effective, innovative automation, and IT solutions.

In addition to being active in various industry groups, Board Member and speaker at many congresses, Marcel is the Executive Director of the OPEN Serialization Communication Standard Group.

The OPEN-SCS Working Group is a consortium of life sciences companies and solution providers who have developed an industry standard for interoperability of serialization components. The Working Group belongs to the non-profit organization OPC Foundation.



**Erich Barnstedt**

Principle Software Engineer Manager, Microsoft  
[erichb@microsoft.com](mailto:erichb@microsoft.com)

## Microsoft OPC UA Cloud Solutions

### IN THIS SECTION:

Learn from an interview with Erich Barnstedt from Microsoft about the role OPC UA plays in industrial IoT. Among other things, he will tell us what open source contributions Microsoft have made to the OPC Foundation, and what the Azure Industrial IoT platform offers.

**MICHAEL CLARK: Please introduce yourself to our readers and tell us about your involvement with OPC technology and the OPC Foundation.**

**ERICH BARNSTEDT:** My name is Erich Barnstedt and I lead the Industrial IoT team at Microsoft. Before joining Microsoft, I was working for a computer games company that was then bought by Microsoft. I've since been with Microsoft for 17 years now.

I've been in the imbedded space, which we now call IoT, but most of my time at Microsoft started with Windows CE, then Microsoft Automotive, then working on the Windows IoT core product, which is something that was introduced when IoT became mainstream. Finally, I moved over with my team to the Azure Industrial IoT engineering team.

**CLARK: Please give us a quick introduction to IoT.**

**BARNSTEDT:** IoT, in general, refers to connecting devices to the internet. So, devices can be coffee machines but they can also be trucks, they can be machines in factories, on oil rigs, planes, or what ever it may be. A lot of the components that make internet connectivity cost-effective became widespread and cheaper, so a lot of companies now see value in connecting their products to the internet to collect telemetry data, to see how people are using their products, and to potentially update the products. One of the big successes in that realm is Tesla, who builds over-the-air updates into their cars, which has been a big help for them. But now, almost anything can be connected to the internet in a cost-effective way.

In general, IoT could be described as the third internet. The first-generation Internet is what people referred to as the web – the World Wide Web



– where we connected companies to one another. The second-generation internet is the Facebook's and the YouTube's of the world, where we connect people. The third, large technological improvement or technological revolution in the internet, is the Internet of Things.

Many analysts think that IoT is, by far, the largest opportunity, in terms of revenue potential, for the IT space. Specifically, manufacturing and natural resources are the largest opportunities within IoT. So, to finish the definition, Industrial IoT refers to the IoT of connecting industrial assets. So, those assets, like I mentioned before, can be machines or entire factories, oil rigs, refineries; all of these things fit under the industrial IoT space, and in terms of vertical markets, fall under Industrial IoT. Certainly, discrete and process manufacturing are a part of that, but we must not forget other sectors, like energy production and distribution, building automation, and mining – these are all part of industrial IoT. As you can see, it's a pretty big field and the top 10 largest companies in the world, apart from Walmart, are all in the industrial space.

**CLARK: What role does Microsoft play in the area of Industrial IoT?**

**BARNSTEDT:** Microsoft has always been a platform company – a platform provider – and our business model is mainly focused on creating software platforms that people can integrate into their products, which is quite different from some of the other cloud vendors out there.

Fundamentally, our biggest business is the enterprise business; working with partners, working with other companies, providing software or platforms to enable their products to be connected. This helps to get business insights from data that they are collecting, connecting different companies to one another, especially for industrial IoT analytics.

Our Windows product has been active in the industrial space for the last 30 years. Being engaged there is not something we've discovered recently and we have developed the largest partner-network in the industrial space. Now, with folks going through what they call their digital transformation, producing products that are connected to the Internet but also automating and digitizing business processes, all of that fits into this space, the industrial IoT space. With the cloud, specifically our Azure product, people now see the value in using cloud technology as a way of providing those new products, helping with the digital transformation.

**CLARK: Can you share some elements of the specific strategy for industrial IoT with our readers?**

**BARNSTEDT:** We've had early successes with going a new route with Microsoft. When Satya Nadella took over as CEO, he set a new course for the company and embraced openness. We realized pretty quickly that, especially in the manufacturing space, this can be a huge competitive advantage and we went all-in with openness. Of course, with the new direction that Microsoft took at the time, this was around 2015, it was easy for us to get support from our senior leadership team. When we began to think about our objectives, we asked ourselves, "if we're embracing openness for the manufacturing space, what should it look like?" We decided that we needed four pillars to make openness complete.

The first pillar we identified was to use an open platform. So, APIs must be based on industry standards, like HTTP REST, certificates based on X.509, user authentication using OpenID, and so on.

The second pillar was open source. So, we really embraced open source within the team; everything we do in the industrial IoT space is open source. Let me be clear, because a lot of people associate open source with demos at Microsoft, that's not the case. These are Microsoft products, it's just that they are developed in the open. So, you know they have the normal support that any other Microsoft product has, but you can look at all the source code. It is all on GitHub, and you can follow our development there, ask questions, log bugs, and, preferably, provide the bug fix if you have it. Although, we also investigate bugs ourselves.

The third pillar that we found to be important is open standards, specifically, industrial standards. This is precisely why we started collaborating with the OPC Foundation very, very closely. Frankly, we were always involved with the OPC Foundation, but we really started to accelerate our collaboration with them when we set the strategy for Industrial IoT.

Then, finally, the fourth pillar is using open data models. Once people figure out how to send data to the cloud, and once they understand that context is important – contextualising the data, making and adding semantic meaning to it – they realize that the data model itself is critically important. So, we decided to use an open data model based on OPC UA

and, currently, we're the only ones using OPC UA data models as a cloud provider. There's lots of industrial IoT clouds out there, but obviously, we're the only ones to have an open data model at the core of our products. This means that, with our product, vendor lock-in is reduced, if not completely removed.

**CLARK: Open source is not the same as free beer. Can you explain what open source means and comment on why Microsoft may be the biggest open source contributor to the OPC Foundation?**

**BARNSTEDT:** First of all, does open source really mean that the software has to be free, as in free beer, so no cost? no, it does not. I remember when I was a student at Trinity College in Dublin, we had Richard Stallman give a talk explaining how lots of people confuse the principles of open source. He's kind of the Godfather of open source, if you don't mind the comparison, and he's behind the general public license.

He agreed that if you can make money with open source, by all means do it. It doesn't mean that you have to give it away for free, it just means that you have nothing to hide when it comes to the implementation of your software. You can protect yourself from piracy through the license agreement, so that's why GPL was built. It's not so much the case that you have to give open source software away for free, although, in the case of Microsoft, that is exactly what we're doing.

All industrial IoT software that Microsoft produces is available for free; but that was a separate discussion and a separate choice we've made. For us, industrial IoT software is an enablement for connecting solutions to one another, building solutions and, of course, you know we make our money with Azure consumption, like other cloud providers. So, we make money on the consumption, not on the software itself, or the software license. That's a big difference. Think of open source in terms of free speech, rather than free beer.

So, regarding why we are a large contributor to the OPC Foundation, it's true we are actually the number-one open source software contributor to the OPC Foundation by a factor of 10. Why did we do that? Well, it was first a necessity. We needed an OPC UA stack that runs on Azure. At that time, the .NET Standard came out, which is a cross platform version of .NET. We took an older .NET stack, which the OPC Foundation used for prototyping purposes, then ported it to a .NET Standard, we hardened it, we fixed a bunch of bugs, we cleaned up the code, we refactored some of the code, we threw out some legacy stuff, and then, we contributed that stack back to the OPC Foundation to accelerate adoption. Now it's the reference stack that OPC Foundation has on GitHub. It's super popular. We've watched it grow from only Microsoft using it, to hundreds and hundreds of people now using this stack. There are over 1000 visitors each day on this particular GitHub repo. We get lots of feedback from folks saying that it's great that the stack is available. It's also driving folks to OPC UA, accelerating the adoption of OPC UA, which is a nice side effect. Our goal was that we really wanted to make sure that the stack gets a lot of adoption, and that it's used in products.

**CLARK: How long has Microsoft been working with the OPC Foundation?**

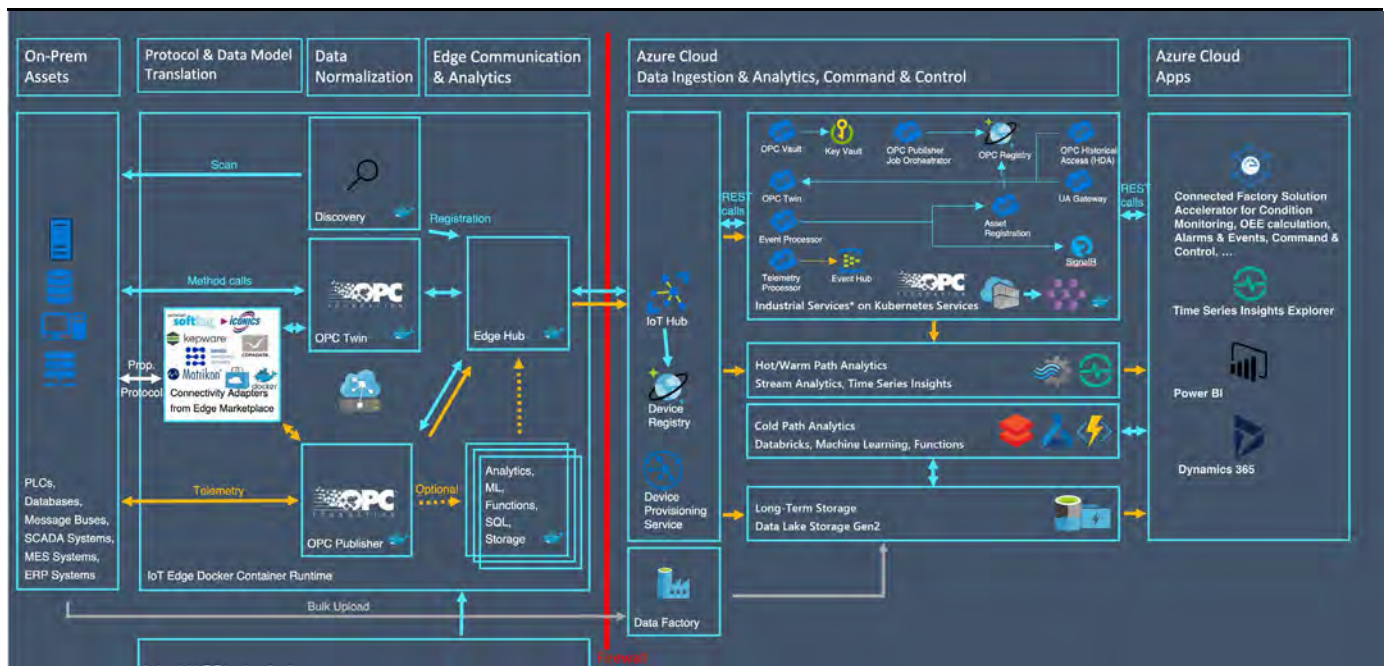

Azure Industrial IoT Platform Architecture

**BARNSTEDT:** We basically didn't do much with OPC UA until our team discovered it in 2015, at which time, we made it an active part of our strategy. We joined the OPC Foundation's Technical Advisory Council, and were offered a seat on the Board of Directors.

We are part of the Unified Architecture Working Group, Security Working Group, the Semantic Modeling Working Group, and also the Asset Management Working Group. So, you can see that we're very active, contributing to the newer versions of the OPC UA specification. One of the biggest contributions to the standard, was the Pub/Sub extension, which is Part 14 of the OPC UA specifications. We made a lot of suggestions and also helped write some of the paragraphs of the specification to explain what the publish subscribe mechanism really is. It's gotten a lot of traction with the Field Level Communication Working Group, but it's also heavily used for cloud communication using OPC UA. For example, a lot of people don't know that OPC UA actually leverages MQTT as a cloud transport. A lot of folks think that OPC UA competes with MQTT. It is actually the contrary; OPC UA leverages MQTT and uses it for communication with the cloud.

**CLARK: Can you please highlight some of Microsoft's products that leverage OPC UA?**

**BARNSTEDT:** We launched OPC Publisher at Hannover Messe in 2015. The OPC Publisher connects to OPC UA-enabled assets, usually machines, PLC's, and so forth, and then it uses Pub/Sub to send telemetry from those assets to the cloud.

Later, in 2016, we launched a solution accelerator called Connected Factory. It also uses OPC UA end-to-end, including OPC UA Security end-to-end for keeping the connection from the asset all the way to the cloud, and back, secure. Again, it's a solution accelerator; we're not in the solutions business, our partners are. We just felt that it was important to show

our partners how a starting point to a solution might look.

Next, we launched OPC Twin, which creates a digital twin of an OPC UA enabled asset. Furthermore, it handles communications in a secure way, from the cloud back to the asset. Lots of folks tend to be worried about having cloud connectivity to an asset within a factory; however, looking closely at the way we've implemented this communication methodology, it keeps the firewall to outside traffic closed. We made sure that security was our number-one goal. We create an outbound connection from the OPC Twin, which runs in a gateway in the factory. It allows for browsing of the OPC UA information model from the cloud. To this day, we are the only cloud vendor that has that functionality. Obviously, since we're using the OPC UA data model, it was a no-brainer to add that to our portfolio. Then, in the following year, we launched OPC Vault which is a global discovery server implementation, described in Part 12 of the OPC Specification. The GDS handles certificate management for OPC UA enabled assets, but, until now, there wasn't a commercial version available, and certainly not a truly global one, which runs in the cloud. So, we built OPC Vault based on our Azure Key Vault product, which is a secure storage and certificate management solution, hence, the name OPC Vault. It manages security and certificates for OPC servers and clients.

In 2019, we launched the Azure Industrial IoT platform. Again, the whole thing is on GitHub. It basically extends and combines all of the products that I've just mentioned into a single platform offering, which can be deployed using a single click of a button. You know, speed is super important right now because a lot of folks see IoT as this nebulous thing that they don't really understand. Obviously, they want to try it out before they invest heavily, so, developing demonstrations is the day-to-day business of our sales team. You really want to be able to deploy a solution and then connect assets in a matter of hours rather than a matter of weeks or months.

**CLARK: You mentioned the Azure Industrial IoT platform. In what way is your cloud strategy different from others?**

**BARNSTEDT:** The unique selling point is the aspect of openness. Like I mentioned before, our platform is as open as you can possibly get, while still leveraging managed services. Our customers say that they don't want to be locked in, they want to be able to leave when they feel like it, but, at the same time, they don't want to manage the solution themselves. They want us to manage it. So, we're leveraging the managed services that are available on Azure, where customers simply use it; they really don't have to do anything. Since the services are managed, they just click a button and have the service available. You don't have to worry about updates, or keeping it running, or making sure it scales; it's just there. Combining those two things together, is a winning formula. We're still the most open cloud platform available. A lot of our competitors are choosing a different strategy, but we believe the strategy of openness is the right one for us.

**CLARK: How much time and effort are required to connect a machine to the Azure Industrial IoT platform?**

**BARNSTEDT:** Speed to deploy is of the essence, especially in scenarios where people just want to see, "Okay, what is this IOT thing; how does it work, and will it work for me?" The most basic use case, where most people feel comfortable starting, is with asset monitoring, which is simply collecting some telemetry data from an asset, like a machine, and seeing it on a global dashboard. Very quickly after that, they want to calculate their Overall Equipment Effectiveness (OEE). For example, Connected Factory does that right out-of-the-box; you can click a button and deploy Connected Factory and start connecting assets to it.

We built an installer for the IoT Edge gateway. You can either set up a VM, or just buy an industrial gateway, and use the installer on that. Again, it's fully automated; you just have to give your gateway a name, tell it where to connect to the cloud, and that's it. Since OPC UA enables discovery automatically, as soon as you run the installer, discovery automatically starts discovering assets. If you would prefer not to allow that, you could, instead, enter the IP addresses of each asset manually. Some folks don't like network scanning on their shop floor networks, so you can turn it off. In general, folks love the simplicity of running an installer, getting everything up and running in minutes. Within less than an hour, you can see all your OPC enabled assets, and you're on your way.

In the event that the asset does not yet support OPC UA, we've worked with Softing and others to create plugins for our IoT Edge gateway solution that handles those devices. It translates proprietary interfaces, from within the asset, into OPC UA. This preserves a consistent information model that is so important.

Once set up, everything is sent to the cloud using OPC UA Pub/Sub, maintaining the consistency of the data stream. It's so important to have a consistent data model, so you can do your analytics on a global scale, comparing all your assets, one to the other, with ease. Again, in the cloud we have pre-built dashboards to visualize the data, including the ability to run analytics.

**CLARK: There can be no Internet of Things without security. What does Microsoft do to provide maximum security over and above OPC UA with its built-in security?**

**BARNSTEDT:** Obviously, security is paramount, especially when you're

controlling critical infrastructure. So, we built security into our values from the start. We decided that everything must be secure by default. Secure by design means that you think about security from the start when you design your product. Secure by default goes one step further, not only building security features into the product, we also switch them on.

It's unfortunate that, in the manufacturing space today, assets may have great security features, but, more often than not, when unpacking that asset from the box, you find that they're all turned off. This lesson was learned the hard way in the 1980s when many of our Windows Server customers became overwhelmed when trying to enable security features, and then really never knowing if they did it right, closing any and all security holes.

Today, our first principle of security is that we turn all of the security features on, by default. So, now, when you take this piece of software into production, it's already secure. In some cases, that may mean that some features don't work the way you expect, because they may be blocked by authentication requirements or other security features. But it's our position that this is a much better approach than keeping the asset insecure, then leaving the asset owner to figure out how to make it secure.

Our second principle of security is defence in depth. "In depth" means that every interacting part of the system is secure. It's not only perimeter defence, but that every asset, within your environment, is secure. This means that a hacker will have to go through several barriers to get to the valuable data that he or she is looking for. This, hopefully, means that the hacker will eventually give up because it is too hard.

Defence in depth is something we've also utilized in Connected Factory, where we don't just secure the dashboard, we also secure the path to the assets, we secure the asset itself, we encrypt all traffic in both directions, sometimes encrypting the data twice, also encrypting the data-at-rest, which is something some folks tend to forget. They may encrypt the data in transit, but then they store it, unencrypted, somewhere on the file system, where that could eventually be compromised, and the data is siphoned off. It's so important to have defence in depth as a design principle.

From there, OPC Vault manages security settings and security certificates for OPC assets, and we leverage OPC UA security throughout. We're one of the few companies that have OPC UA enabled assets secure by default, because security profile "none" is turned off. Again, this means that folks, who don't understand security certificates, will struggle at first to make things work, but with OPC Vault, we really try to simplify that process as much as possible.

We are also campaigning for the automatic installation of certificates, such that they can be automatically rolled, so that they are not valid for 30 years. Instead, make a certificate valid for six months, and then automatically renew the certificate every six months. That's the better approach, and for this to work, it needs to be automated. We're really pushing the industry to support the automatic installation of security certificates – called GDS push.

**CLARK: What does the future hold for Microsoft's support of OPC UA?**

**BARNSTEDT:** OPC UA doesn't stand still. The OPC UA specification is constantly developing further features that are no longer in use or depre-

cated to keep it manageable. OPC UA looks overwhelming if you first look at the specification, I mean, there's 15 or 16 parts now. Each specification is several-hundred pages, and it seems daunting to read it all. The good news is, you don't have to. First of all, most product vendors would simply buy a stack, rather than build their own. The other thing is, not everything in the OPC UA specification applies to every use case, that's why there are profiles.

In general, when it comes to what else is happening in the world of OPC UA, you may know that VDMA is currently standardizing the information models for each machine type, which is super-critical work, which Microsoft eagerly supports. So, OPC UA specifies how to build an information model but doesn't specify, for any particular machine type, what that information model should look like. The VDMA is now working, on a massive scale, to define just that. This will result in a host of standardized information models, meaning that users can build dashboards and analytics pipelines before seeing the machine for the first time. This is a huge advantage.

There's going to be more and more expansion of OPC UA in other verticals of industrial IoT, including a consolidation in the process automation industry. There's standardized information models built, like PADIM, which is the process automation device information model. It's an OPC UA information model that folks like the FieldComm Group, NAMUR, and The Open Group have been flocking to OPC technologies and basing their reference architectures on OPC UA.

Something else that's changing for the better, even though the OPC Foundation is an American, non-profit organization, OPC UA has seen wide adoption in Europe and Asia. Remarkably, I would say that, in North America, it has been relatively unknown. Sure, people know about OPC UA, but they haven't necessarily built it into their products. Fortunately, this is now changing; there's a lot of momentum building in the US and Canada, which is great. This is super important.

In terms of how OPC UA technology is further developing, folks have asked that OPC UA servers be built into containers. Containers are basically a software distribution mechanism that is getting a lot of traction, especially with cloud platforms. Microsoft contributed container support for servers to the OPC Foundation. We contributed the functionality to create NuGet packages, which is something that a lot of developers appreciate, because it's super-simple to integrate a library into your product using NuGet.

Perhaps I'll conclude by mentioning that there are new security profiles being introduced with elliptic curve cryptography. So, technology advancements don't stand still; clearly, there's always room for improvement. This is how OPC UA continues to improve and move with the times.

**CLARK: Let's talk about the topic of the day, COVID-19. What challenges and opportunities are evident for folks using OPC UA?**

**BARNSTEDT:** I mean, if there is a silver lining in this current crisis – the global pandemic – it's that folks are now thinking about accelerating their digital transformation or, in general, the automation of their production processes. This is great, since OPC UA is a technology of enablement. Of course, I wish it would have happened through other circumstances.

The particular increase in adoption is because supply chains are fragile and manual production is more fragile, especially when health and safety can't be guaranteed in the factory. These are all the enablers, or the results, of this pandemic, and hopefully something good will come out of this. We need to automate more manual labor on the production line. There will be new jobs created through automation. As we know, most of the time, more jobs are created than previously existed. From that perspective, it's not a question of destroying jobs, but creating new ones in a different capacity.

---

**ABOUT THE INTERVIEW PARTNER:**

Erich Barnstedt has been working for Microsoft for almost 18 years in various technical roles and currently is an engineering manager in the Azure Industrial IoT team. In his role, Erich is responsible for the product development of Azure Cloud offerings as well as international standards work in the industrial space, especially within the OPC Foundation. Erich holds a bachelor and two masters in Computer Science from Trinity College, Dublin.



Thomas Usländer, Head of Department "Information Management and Production Control (ILT)" Spokesperson of Business Unit "Automation and Digitalization" thomas.uslaender@iosb.fraunhofer.de

## Smart Factory Web

### IN THIS SECTION:

Thomas Usländer from Fraunhofer IOSB research institute describes the Smart Factory Web and the role it plays in OPC UA. Among other things, Thomas will discuss major trends in smart manufacturing, discuss Smart Factory Web, how it relates to IoT and other initiatives, and why they chose OPC UA as their underlying architecture.

**MICHAEL CLARK: Thomas, please introduce yourself to our readers and tell us about Fraunhofer's involvement with OPC technology and the OPC Foundation.**

**THOMAS USLÄNDER:** I am a computer scientist, having studied at the University of Karlsruhe in the '80s. I received my Ph.D. from the Karlsruhe Institute of Technology (KIT) in 2010. For many years I've worked here at the Fraunhofer IOSB in Karlsruhe in the Southwest of Germany, close to the French border. IOSB is one of about 70 Fraunhofer institutes. IOSB stands for Institute of Optronics, System Technologies, and Image Exploitation, which is a long and complicated name. At the end of the day, it's about IoT, the Internet of Things, especially the Industrial Internet of Things, along with all the nice applications that we can put on top in order to support the decision makers. I am the department head of Information Management and Production Control, and also a spokesperson for our business unit Automation and Digitalization where we bring together the competences of several departments. In this role, I organize all our research activities in the domain of industrial production, but also digitalization

of the automation environment of the industrial production. After my studies, I started working here at Fraunhofer, but then went to industry to work in open network management, based on ISO and Internet standards. Step by step, I got other work in middleware systems, while already back at Fraunhofer IOSB as a group manager. As I organized our activities in CORBA-based environments, I was already involved in the Object Management Group activities. However, at that time,

### Demands

- higher resilience
- sustainable production
- more flexibility
- higher product variance
- manufacturing on demand
- smaller lot sizes

Source: Fraunhofer IOSB



supply chain level

factory level



### Marketplace



Manufacturing and Logistics as a Service



the domain was different; I was not in industrial production; I was in environmental information systems or the environmental risk management and geospatial architectures. Today, we would say that I was in another domain of the Internet of Things, but in those days, although the term was already created, it was not used. It was called Sensor Web Enablement, a term created by the Open Geospatial Consortium (OGC) where I was involved. The OGC is still active and very alive, but not linked currently to this domain of Industrie4.0, where I am today. Nevertheless, there are nice trends that might bring all these activities together. In our activities of applied research, the openness of architectures was always in the centre of our activity, and still is today. If it were open geospatial architectures for environmental risk management, or even including remote sensing systems, or if it is in smart cities or industrial production, the openness and interoperability is within the core of our activities. I'm trying to bring this over within my department. There are about 40 researchers that are organized into six groups and they all, more or less, have this spirit in mind.

**CLARK: Thomas, can you please share with us which are the major trends in smart manufacturing?**

**USLÄNDER:** There is a lot of dynamics coming from the market, both from the user side but also from the technological side. We see that there is a demand for higher resilience, but there is also a trend towards sustainable production. On the one hand, this means being resource-efficient in production or energy-efficient in production, on the other hand, sustainability also refers to the quality of the product, or to the materials that are processed. The generated sustainability is a demand that is much more important.

Furthermore, there is a trend towards more flexibility. Here we see that this trend is not only on the factory level but more and more on the supply chain level, where all the materials and parts come from. Now, in these times of the Corona Crisis, we see that companies are too fixed to their existing supply chains.

What we also see, and what has also led to the generation of several initiatives such as Industrie4.0, is higher variance of products and smaller lot sizes. This leads us to the topic of today, because all these products should be more and more manufactured on-demand, in a short time-frame, and that is why we need other strategies to produce products, and to plan the engineering at the production phases. All this, both on the factory level and on the supply chain level.

**CLARK: What is the Smart Factory Web and what does it stand for?**

**USLÄNDER:** The Smart Factory Web was created during a joint activity with the Korean research institute entitled KETI (Korean Electronics Technology Institute). We came together after I gave a presentation at the Hannover Trade Fair, some years ago, about the openness in the Internet of Things. I talked about the European project entitled OpenIoT. Once they heard this presentation, KETI was interested.

We discussed what we could do together. One idea was to simply connect our model factories, our smart factories, that we have in our research institutes; and why not do that via the Internet, via a kind of central portal that allows us to connect our factories together. This was our start-

ing point and we thought that we should do this based on open standards; to try out what these standards could do and discover any of their limits.

As we are both members of the Industrial Internet Consortium (IIC), we defined an IIC testbed, which turned out to be a good marketing opportunity. We called this testbed Smart Factory Web.

Why did we call it Smart Factory Web? Well, the term World Wide Web is more or less a web or a network of information, instantiated documents. Similarly, we wanted to create a web of smart factories. Step by step we defined the system and the testbed, which was finally accepted by the IIC. We are very proud to be the first Fraunhofer Institute to have created an IIC testbed.

Over the next few years, the system turned into a blueprint architecture for a marketplace for industrial production. Originally, this was not foreseen, but we concluded that what we are doing is very similar to what has happened in other business branches like tourism or mobility. For example, if you want to book a hotel today, or perhaps a car, you simply go to a portal where companies like Booking.com, TripAdvisor, Uber, and others, are all working in this platform economy; they don't own these assets, they are just mediating the access and the services of these assets. Why should we not pursue the same idea in industrial production? We saw that the Smart Factory Web has the potential to go in this direction and we are now discussing a platform economy for industrial production. It's not just how to connect two or four factories, like it was in the beginning; it's that we are now trying to define the whole marketplace based on open standards. This was a great step forward, which also turned out to be quite attractive when presenting this at international trade fairs.

**CLARK: How does Smart Factory Web relate to the Industrie4.0 initiative? And how does the Smart Factory Web architecture fit into the Reference Architecture Model Industrie 4.0 (RAMI4.0)?**

**USLÄNDER:** From the beginning, we did not want to only be a kind of instantiation of the IIRA, the Industrial Internet Reference Architecture defined by the IIC. We also wanted to align with the RAMI4.0, the Reference Architecture Model defined by the Platform Industrie4.0. It fits very well because, with the RAMI model in mind, there are three dimensions, and one of the dimensions is the dimension of Asset Types. These range from products, sensors, actuators, shopfloor devices, and enterprises, up to the connected world. We are targeting the latter two asset types, i.e., the whole factory/enterprise level and the connected world, which joins multiple enterprises together. The connected world mirrors the idea of a supply chain.

**CLARK: Which Industrie4.0 technological concepts do you use?**

**USLÄNDER:** If you create a marketplace for industrial production, you have to represent factories in the virtual world. Today, we could say that we're creating a kind of digital twin of this factory. In order to do that, in an internationally acceptable way, covering several branches, you need a standard way to represent those factories. The Industrie 4.0 concepts associated with the so-called Asset Administration Shell (AAS) are perfect because, it provides an abstraction of any type of asset. As an asset type, we would use the whole factory, but also the machines inside this factory. Since we want to have a common interface, and we want to have a com-

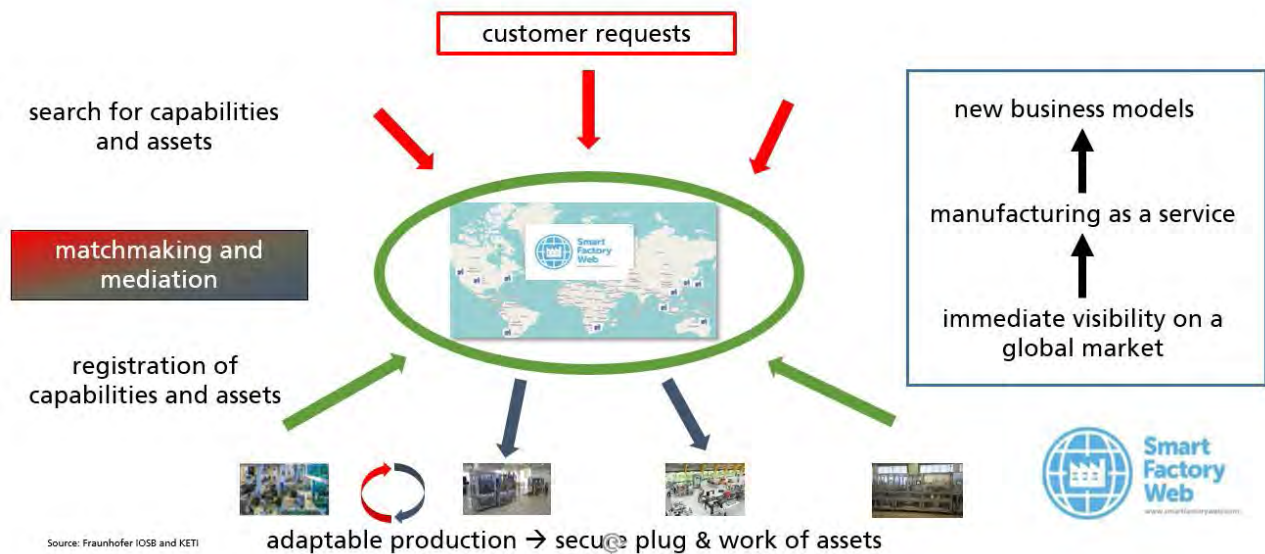

*Towards a Marketplace for Industrial Production*

mon way of modeling these assets, we chose the Asset Administration Shell as the basic approach to do this.

**CLARK: What type of standards do you use within the Smart Factory Web?**

**USLÄNDER:** We are using three types of standards. First, we needed to define how to communicate with and model the factory; for this, we choose OPC UA. It was quite natural for us to do so because we are familiar with this technology and it offers flexibility and freedom, and the interoperability we need for such a marketplace.

Secondly, since there are no data models for whole factories yet, we do not have companion specs for this asset type. We started to model the factory capabilities and associated assets using another IEC standard called Automation Markup Language or AutomationML. This became quite easy for us to use because a research group in my department already defined a mapping from AutomationML to OPC UA in a DIN specification, which is also an OPC UA companion specification. We started to model the assets, the capabilities, and their properties, with AutomationML and created a generator which instantiated OPC UA data models and servers.

The third standard that we are using is the SensorThings API of the Open Geospatial Consortium. It was quite beneficial that we were already working with OGC, where all these geospatial aspects are discussed. SensorThings API allows us to retrieve sensor data in order to realize sensor data management in a standard way.

**CLARK: Why did you choose OPC UA and AutomationML? How and where does it fit in?**

**USLÄNDER:** AutomationML is a data exchange standard for the engineering of products, i.e. it provides a standard way to exchange data between engineering tools. We are one of the founding members of the AutomationML Foundation. It's just about data modeling, it is a container meta-model that is used to store particular properties of assets.

In order to communicate this information, we needed another standard. Here, OPC UA is quite straightforward and the mapping is natural. OPC UA is a communication protocol, and we are using both embedded paradigms, the client/server paradigm and the publish/subscribe paradigm. Subsequently, we need the data and the semantics; semantics about the properties of a factory and its assets. This is provided by using AutomationML, collecting semantic annotation possibilities into ontologies. AutomationML represents the “what,” while OPC UA represents the “how.”

**CLARK: What role does OPC UA play with respect to Smart Factory Web and the Cloud?**

**USLÄNDER:** For us it's the interface between the marketplace, the portal system (where the customer tries to search for capabilities of factories to produce something), and the factories themselves. It's the upper interface by which a factory is represented in such a marketplace. A lot of people are talking about IT and OT convergence; we see it represented here, since these representations of factory capabilities are not just in the OT realms, but also in the IT world. In our case, OPC UA is a natural fit, although we are acting more on an enterprise level. OPC UA is a kind of worldwide language for automation. We see benefits at the enterprise level, primarily because it doesn't matter if this information is directly communicated bilaterally or via some cloud application. Perhaps this is why the positioning of OPC UA is getting much looser; it's not only fixed to shopfloor communication, it's also used in other entities, like edge-to-cloud architectural environments.

**CLARK: How does Smart Factory Web relate to International Data Spaces?**

**USLÄNDER:** This is a very interesting movement and development. We are members of the International Data Space Association (IDSA) which is an association concerned about data sovereignty. Typically, the discussion is about how to access asset information and how to control the access. This refers to controlling who is permitted to access which types of information, under which circumstances, and under which constraints. This looks like a typical access control model, but once we have given out



Visualization of Supply Chains in the Smart Factory Web Portal

that information, where somebody now has access to that data, control is lost. With the help of International Data Spaces, we want to change this in order to address aspects like data usage control.

Analogously to access control policies, we envision new data usage control policies. For example, you might give data to somebody with whom you don't have a trusted relationship, thus allowing them to use the data, but only for a specific purpose. You may also put a restricted timeline on its use – three weeks, two months – but then they have to delete it. On the other hand, those who consume the data may want to know the source of the data; in other words, the provenance of the data.

These two aspects – data usage control and data provenance tracking – are the core added values of the International Data Spaces. We further see that, in a marketplace where supply chain information is included, data usage control is required. That is why we have started to include not only Industrie4.0 technologies but also IDS technologies into our Smart Factory Web. Companies could then decide whether to be involved in such a marketplace, which type of data they give out, and for which purposes that data may be used. This is very important because factory owners tend to be a little bit reluctant to give out this sensitive data to a marketplace.

**CLARK: What are the interesting aspects of Smart Factory Web for you as a researcher?**

**USLÄNDER:** As a researcher, there are many aspects in the Smart Factory Web that are interesting. On one hand, there is this data sharing aspect, data sovereignty; how to ensure it, but also how to enforce it. What are the technological boundaries for policy enforcement and what do you have to include and assure through contracts?

We cannot solve all of these questions on a technological basis. Finding the right boundaries and the right architectures are research topics that we are discussing. This is becoming very important in this new data ecosystem of GAIA-X. The GAIA-X foundation was created very recently. IDS technology, together with Industrie4.0 technology, will play a great role in GAIA-X, but that's perhaps a story for another day.

On the other hand, there is the marketplace itself. How can you mediate

a request from a customer who wants to get a product produced? One who has a description of a product, perhaps in a formal way as a STEP document, or in informal ways, or as a textual document? How can you mediate this, semi-automatically, to a description of production capabilities in such a platform? Once you have found candidate factories, how is it then possible to support the commercial negotiation between the customer and the factory owner? What types of business models can be supported? We want to optimize the negotiation time for new partners. This is an important research aspect, which we have chosen to address in another IIC testbed – The Negotiation Automation Platform testbed – together with our partner, NEC of Japan. This testbed is relying upon the architecture and the software system of the Smart Factory Web.

**CLARK: What are the business aspects of the Smart Factory Web?**

**USLÄNDER:** I would like to split this into two answers. I would first like to address the business aspects of a portal like the Smart Factory Web marketplace itself. Then I will address the business aspects for us as a research institute.

First of all, there are several business models that can be run in the marketplace; the question is, how to earn money with such an approach. This could be done through a kind of mediation role where money can be earned through advertisements, which means you become the broker, negotiating between the customer and the factory owner.

On the other end of the spectrum is the tourism industry model, where the marketplace takes over responsibility for delivery, meeting the required quality. In this model, the market place is somewhat of a black-box from the customers viewpoint. The customer outlines their demands, quality requirements, perhaps their sustainability, ecological and ethical constraints, leaving the responsibility with the marketplace to meet the customers demands.

For us as a research Institute, we can benefit from developing and hosting this system, by getting into discussions with big players and with various stakeholders of industrial production. If you visit the website of the Smart Factory Web, you will see two important business partners, Microsoft Corporation and SAP. Both of these big IT players have a major interest in the Smart Factory Web system. We are discussing how to integrate our learnings with their products so that, at the end of the day, there is a

common offering in the marketplace, bringing together our respective competencies, but then operationalizing this experimental marketplace into a real commercial offering.

**CLARK: For our readers, those from user companies or research institutes, who may have interest in engaging with the Smart Factory Web, how can they participate?**

**USLÄNDER:** There is a call for participation on our website. Just go to [www.smartfactoryweb.de](http://www.smartfactoryweb.de) to express your interest. There, you will find information about the architecture and technologies we are using. There are also white papers of the Smart Factory Web in the IIC document store.

Another way to participate would be to take the software of the Smart Factory Web, or at least the architecture, and try to implement it into a real operational marketplace system of a particular industrial branch. You could imagine, someone doing this would be our most welcome cooperation partner because Fraunhofer does applied research. We are never satisfied by collecting only a few nice results at the research level, we want to see that these ideas become operational, finally becoming an innovation.

**CLARK: In closing, do you wish to share any final thoughts with our readers?**

**USLÄNDER:** We have been discussing this idea of a marketplace for industrial production for many years now. When I talk about this in conferences, many people say “This is interesting, let’s talk about it,” but perhaps people do not yet see the disruptive aspects of this approach. It has come to our attention that there are new start-up companies that go that way. In these days of the digitalization of the industrial production, long-standing companies have to be very careful that they do not lose these new business opportunities. Maybe, they should build-up such marketplaces on their own, together with cooperation partners, or even together with their competitors. If they do so, they should do it in accordance with worldwide standards, constraints, and rules on data sovereignty. If there are partners that are willing to cooperate with us on these topics, they are most welcome.

---

**ABOUT THE INTERVIEW PARTNER:**

Curriculum Vitae of Dr.-Ing. Thomas Usländer

Thomas Usländer holds a degree in Computer Science from the University of Karlsruhe, Germany, and a PhD in Engineering of the Karlsruhe Institute of Technology (KIT), Germany. He is head of the department “Information Management and Production Control” and spokesperson of the business unit “Automation and Digitalization” at Fraunhofer IOSB. His research interests include agile system and service engineering, AI engineering, open architectures, connectivity and communication standards as well as sensor data management for the Industrial Internet of Things and Industrie 4.0 where he has numerous publications and has given several invited keynotes in international conferences.

He is member of the the expert panel of the Standardization Council Industrie 4.0, represents Fraunhofer IOSB in several working committees

---

on “Industrie4.0” and is entitled to vote for Fraunhofer in the Open Geospatial Consortium (OGC).

He was an invited expert of the European Commission, got the DIN Innovation Award 2017, the Object Management Group (OMG) Application Award 2000 and several best-paper awards in international conferences. Since August 2020 he is head of the Competence Center Karlsruhe on AI Engineering (CC-KING).

CC-KING: <https://www.ai-engineering.eu>

LinkedIn: <https://www.linkedin.com/in/tuslaender>

Research Gate: [https://www.researchgate.net/profile/Thomas\\_Uslaender](https://www.researchgate.net/profile/Thomas_Uslaender)

Twitter: @TUslaender

# OPC UA based Industrial Interoperability

## INTEROPERABILITY ROBUSTNESS & SECURITY

- Vendor, Platform, Market and OS agnostic
- Specifications open available/Open Source on GitHub
- Certification: OPC Labs open to everyone
- Scalable From Sensor to Cloud (and back)
- Discoverable Services Oriented Architecture
- Independent of transport protocol (TCP, UDP, MQTT, ...)
- Extendable for TSN, SPE, APL, 5G, Wifi6
- Widely Adopted: > 50 M install base
- Security Design from Ground up:
  - Security on 3 layers: User / Application / Transport
  - Security include Authentication / Signing / Encryption
- OPC Foundation: Non-Profit with modern IPR policy also protecting implementers and users



## 58+ JOINT WORKING GROUPS DATA MODELLING / HARMONIZATION

58+

- **Graph Support**, preserves source context
- Vendor **extendable** data model via Companion Specifications
- **Relevant**: Enables domain specific information models
  - **Discrete**: Robotics, Machine Vision, ...
  - **Process**: FDI, FDT, PA-DIM, MDIS, NOA ...
  - **Energy**: IEC61850, ...

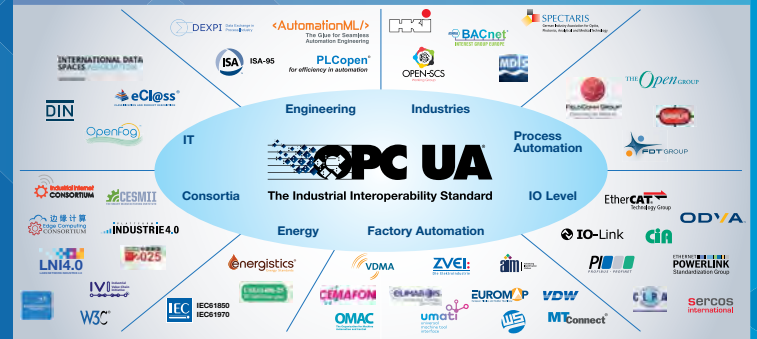

## VALIDATION / CERTIFICATION

### Validation of OPC UA and Companion Specs Compliance Test Tool (CTT):

- Open available
- 1800 test scripts for the OPC UA core functionality and for the Companion Specifications – available now PA-DIM/PLCoPen/MDIS

The screenshots illustrate the OPC UA CTT (Compliance Test Tool) workflow:

- CS Template**: Base for writing CS (Companion Specification)
- Validator**: Check if NodeSet and Spec are in sync
- OPC UA CTT**: Electronic description of Model
- NodeSet-File**: Base for writing CS

## ONLINE REFERENCE

- Public reference with all specifications and all models  
[www.reference.opcfoundation.org](http://www.reference.opcfoundation.org)
- Online searchable to simplify reuse of modeling concepts

The screenshots demonstrate the OPC UA Online Reference website features:

- Online Reference**: Browse through Joint Companion Specifications.
- Search**: Search within the OPC UA Online Reference.
- Content**: Detailed view of an identification functional group.



#### OPC FOUNDATION HEADQUARTERS

OPC Foundation  
16101 N. 82nd Street, Suite 3B  
Scottsdale, AZ 85260-1868 USA  
Phone: 480 483-6644  
office@opcfoundation.org

#### OPC FOUNDATION EUROPE

opceurope@opcfoundation.org

#### OPC FOUNDATION CHINA

opcchina@opcfoundation.org

#### OPC FOUNDATION JAPAN

opcjapan@opcfoundation.org

#### OPC FOUNDATION KOREA

opckorea@opcfoundation.org

#### OPC FOUNDATION ASEAN

opcasean@opcfoundation.org

#### OPC FOUNDATION INDIA

opcindia@opcfoundation.org

Produced In Association with:



A subsidiary of the International  
Society of Automation

[www.opcfoundation.org](http://www.opcfoundation.org)